



# **Korenix JetNet 4006 / 4006f Industrial 6-port Managed Switch**

---

## **User Manual**

Version 1.1, 17-DEC, 2012



**[www.korenix.com](http://www.korenix.com)**



# **Korenix JetNet 4006/4006f Industrial 6-port Managed Switch User Manual**

## **Copyright Notice**

Copyright © 2008 Korenix Technology Co., Ltd.

All rights reserved.

Reproduction in any form or by any means without permission is prohibited.



## **Federal Communications Commission (FCC) Statement**

This equipment has been tested and found to comply with the limits for a Class A digital device, pursuant to Part 15 of the FCC Rules. These limits are designed to provide reasonable protection against harmful interference when the equipment is operated in a commercial environment. This equipment generates, uses, and can radiate radio frequency energy and, if not installed and used in accordance with the instruction manual, may cause harmful interference to radio communications. Operation of this equipment in a residential area is likely to cause harmful interference in which case the user will be required to correct the interference at his own expense.

The user is cautioned that changes and modifications made to the equipment without approval of the manufacturer could void the user's authority to operate this equipment.

.

# Index

<b>1</b>	<b>Introduction</b> .....	<b>1</b>
1.1	Overview .....	1
1.2	Product Features.....	1
1.3	Package Checklist .....	2
<b>2</b>	<b>Hardware Installation</b> .....	<b>2</b>
2.1	Hardware Introduction.....	2
2.2	Wiring Power Inputs .....	5
2.3	Wiring Digital Output.....	6
2.4	Wiring Earth Ground .....	6
2.5	Wiring 10/100Base-TX Fast Ethernet Ports .....	6
2.6	Wiring the fiber port- JetNet 4006f.....	7
2.7	Wiring RS-232 Console Cable and pin assignment .....	8
2.8	DIN-Rail Mounting Installation .....	9
2.9	Wall-Mount Installation.....	9
<b>3</b>	<b>Preparation for Management</b> .....	<b>10</b>
3.1	Preparation for Serial Console .....	10
3.2	Preparation for Web Interface.....	11
3.3	Preparation for Telnet Console .....	13
<b>4</b>	<b>Feature Configuration</b> .....	<b>16</b>
4.1	Command Line Interface (CLI) Introduction .....	17
4.2	Basic Settings .....	22
4.3	Port Configuration .....	37
4.4	Network Redundancy.....	40
4.5	VLAN.....	50
4.6	Traffic Prioritization .....	53
4.7	Multicast Filtering .....	57
4.8	SNMP .....	61
4.9	Security .....	65
4.10	Warning.....	66
4.11	Monitoring and Diagnostic .....	75
4.12	Device Front Panel .....	80
4.13	Save to Flash .....	80
4.14	Logout .....	81
<b>5</b>	<b>Appendix</b> .....	<b>82</b>
5.1	Product Specifications .....	82
5.2	Pin Assignment for RS-232 Console Cable.....	83
5.3	Korenix Private MIB .....	84
5.4	Revision History .....	85
5.5	About <i>Korenix</i> .....	86

# 1 Introduction

Welcome to the *Korenix JetNet 4006/4006f Industrial Managed Ethernet (PoE) Switch User Manual*. The following topics are covered in this chapter:

## 1.1 Overview

### 1.2 Product Features

### 1.3 Package Checklist

## 1.1 Overview

Korenix JetNet 4006 series are industrial managed fast Ethernet switch equipped with 4 10/100 Mbps ports plus 2 10/100 Mbps RJ-45 or 2 100Mbps Fiber uplink ports. Combined with L2 management features, JetNet 4006 series can be remotely managed via Web browser, SNMP and telnet. It also supports RS-232 serial interface for local configuration.

JetNet 4006 series are designed with a slim rugged aluminum alloy injection case with great heat radiation ability to work reliably under high temperature environment. To provide more reliability for industrial applications, it supports wide range power input DC 12~48V with auto polarity reverse function.

With full L2 software features, JetNet 4006 series can provide more redundancy while ensuring secure and reliable data transmission. It supports fast network ring recovery technology - the Rapid Super Ring (R.S.R.) with less than 5ms ring failure recovery time, which co-exists with IEEE 802.1d RSTP:2004 standard to deliver non-stop transmission by Rapid Dual Homing (R.D.H.) technology. To build a smart, cost-efficient industrial Ethernet infrastructure, JetNet 4006 series is the best choice

## 1.2 Product Features

The *Korenix JetNet 4006/4006f* has the following features:

- SNMP, Web, Telnet and JetView Pro Management
- Patented Multiple Super Ring - Network Recovery time < 5 ms
- Patented Rapid Dual Homing – compatible with RSTP
- Port Based VLAN with Tag Modification
- DHCP Client/Server/ DHCP Relay (Option 82)
- IEEE 802.1AB LLDP for Auto Network Device Discovery
- IEEE 802.1p QoS with CoS, DSCP scheme
- IGMP Snooping with Query Mode
- 1.2KV Hi-Pot testing passed (IEEE standard compliance)
- Redundant power input with polarity reverse protection

**Note: Detailed specifications are listed in *Appendix 5.1***

## 1.3 Package Checklist

The *Korenix JetNet 4006/4006f* includes the following items:

- One switch- *JetNet 4006* or *JetNet 4006f*
- One DIN-Rail clip
- One wall mounting plate and screws
- One RS-232 DB-9 to RJ-45 console cable
- Documentation and Software CD
- Quick Installation Guide

If any of the above items are missing or damaged, please contact your local sales representative.

# 2 Hardware Installation

The following topics are covered in this chapter:

## 2.1 Hardware Introduction

- Dimensions
- Panel Layout
- Bottom View

## 2.2 Wiring Power Inputs

## 2.3 Wiring Digital Input

## 2.4 Wiring Relay Output

## 2.5 Wiring Fast Ethernet Ports

## 2.6 Wiring Combo Ports

## 2.7 Wiring RS-232 console cable and pin assignment

## 2.8 DIN-Rail Mounting Installation

## 2.9 Wall-Mount Installation

## 2.1 Hardware Introduction

### Dimensions

*JetNet 4006/4006f* Industrial Gigabit Switch dimensions:

174.8mm W x 46.5mm H x 136mm D (6.98"W x 1.82"H x 5.31"D)

JetNet 4006

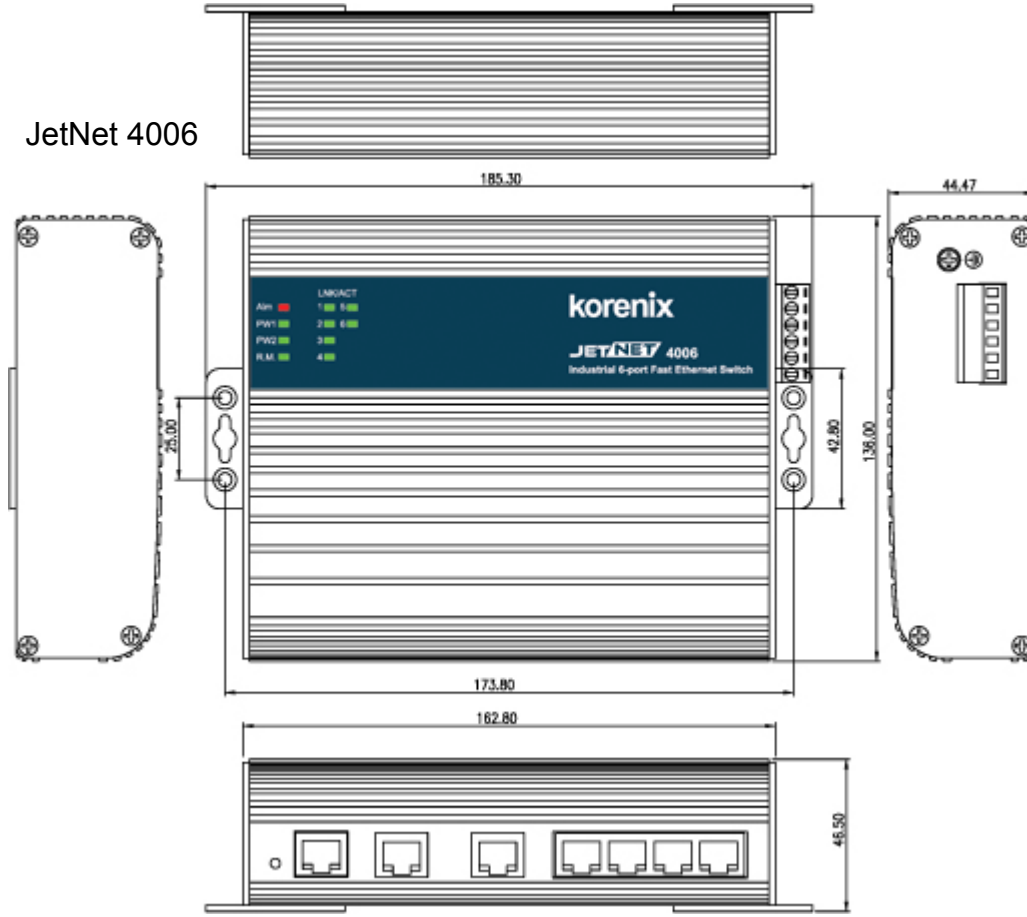

JetNet 4006f

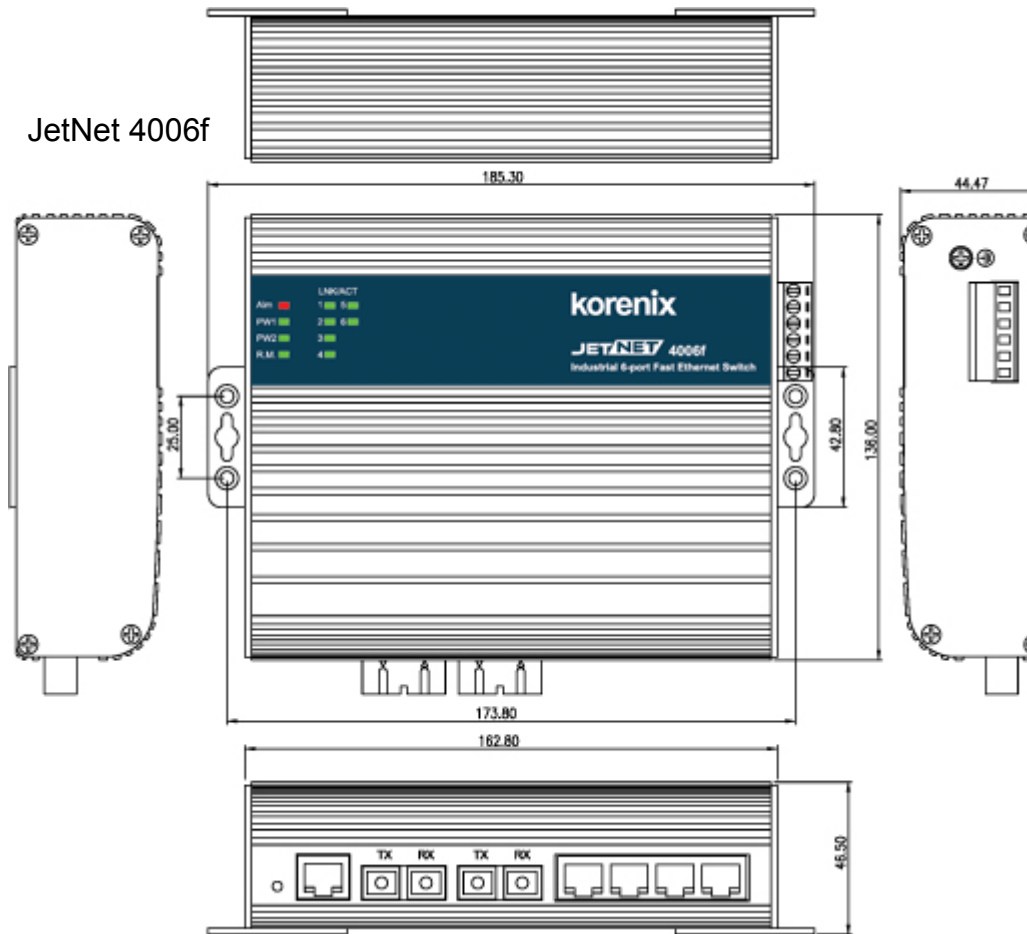

There is one Mylar stick on the top side of the *JetNet 4006/4006f*. It includes four LEDs for the system alarm, power, and Ring Master; and ten LEDs for the port operating status. For details, please check the following figure *Mylar Layout*.



*Mylar Layout*

## Port Layout

*JetNet 4006/4006f* includes 6 -Port 10/100TX (JetNet 4006), 4-Port 10/100TX plus 2 100Mbps Fiber (JetNet 4006f). There is also 1 reset button and 1 console port in RJ-45 type connector. See the following figures.



*JetNet 4006*

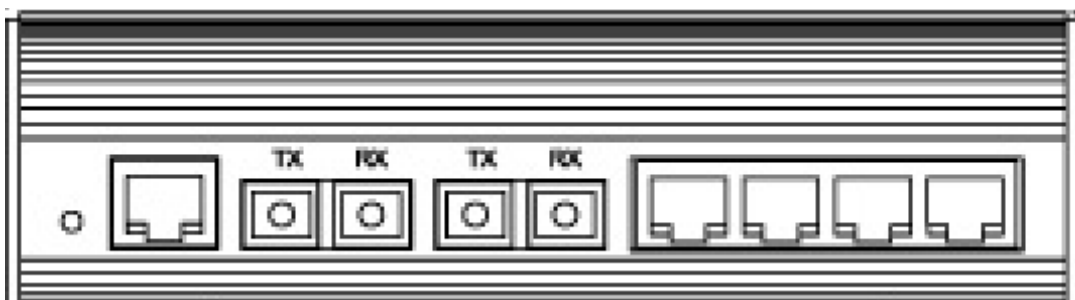

*JetNet 4006f*

## Side View



On the right-side of the *JetNet 4006/4006f* Industrial Managed Switch, there is a terminal block connector and earth ground screw. The terminal block connector includes 2 power inputs and 1 relay alarm output.

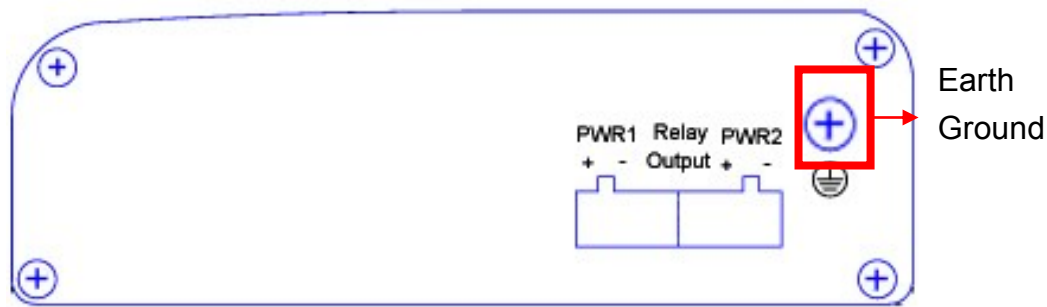

## 2.2 Wiring Power Inputs

Follow the steps below to wire *JetNet 4006/4006f* redundant DC power inputs.

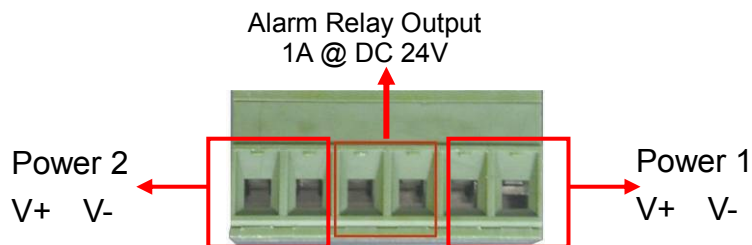

1. Make sure the power terminal block is unplugged.
2. Insert the positive and negative wires into the respective V+ and V- terminal block connector contacts.
3. Tighten the wire-clamp screws to prevent DC wires from becoming loose.
4. Power 1 and Power 2 support power redundancy and polarity reverse protection functions.
5. Positive and negative power system inputs are both accepted, but Power 1 and Power 2 must apply the same mode.

**Note 1:** Remember to unplug the power terminal block before making wire connections. Otherwise, your screwdriver can inadvertently short your terminal connections to the grounded enclosure.

**Note 2:** Suitable electric wire ranges from 12 to 24 AWG.

**Note 3:** If the 2 power inputs are both connected, *JetNet 4006/4006f* will be powered from the highest connected voltage. The unit will signal an alarm for loss of power in either PWR1 or PWR2.

The following diagram is the wiring architecture for your reference. Be sure the power supply is UL Listed Power supply with output Rating 12-48 Vdc, minimum 2.5 A

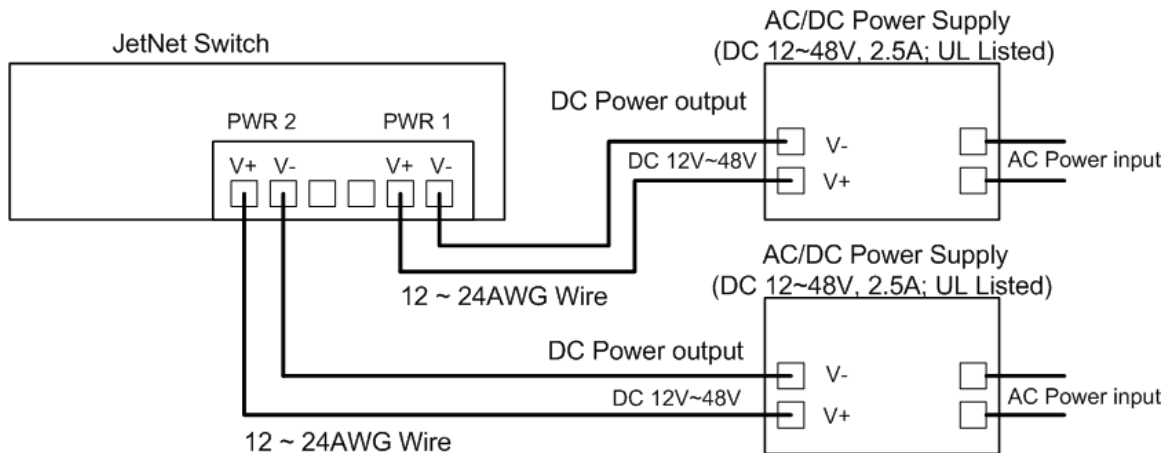

## 2.3 Wiring Digital Output

*JetNet 4006/4006f* provides one digital output, also known as Relay Output. The relay contacts are energized (open) for normal operation and will close under faulty conditions; faulty conditions can include power failure, Ethernet port link break, or other predefined events configurable in the *JetNet4006/4006f* user interface.

Wiring the digital output is exactly the same as wiring power inputs introduced in section 2.2 (see 2.2 *Wiring Power Inputs*).

## 2.4 Wiring Earth Ground

To ensure the system will not be damaged by noise or electric shock, we suggest making a direct connection between the *JetNet 4006/4006f* and earth ground to avoid system damage.

1. On the right side of the *JetNet 4006/4006f*, there is one earth ground screw.
2. Loosen the earth ground screw with a screwdriver
3. Tighten the screw after the earth ground wire is connected.

## 2.5 Wiring 10/100Base-TX Fast Ethernet Ports

The *JetNet 4006/4006f* is equipped with 4 or 6 10/100Base-TX Fast Ethernet ports support 10Base-T and 100Base-TX, full or half duplex modes with auto MDI/MDI-X. All the 10/100Base-TX Fast Ethernet ports will auto-detect signals from connected devices in order to decide the correct link speed and duplex mode. Auto MDI/MDIX allows users to connect another switch, hub or workstation without changing Straight-Through or Crossover Cables.

Note that Crossover Cables cross-connect the transmitter lines to the receiver lines at the opposite end.

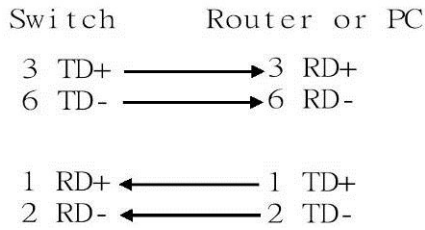

Straight-Through Cabling Schematic

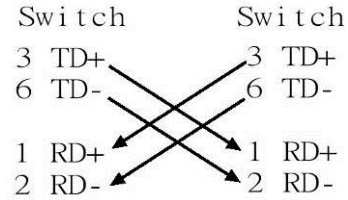

Crossover Cabling Schematic

**Note:** The Ethernet cables use pins 1, 2, 3, and 6 of an 8-pin RJ-45 connector. The signals of these pins are converted by the automatic MDI-X function, as shown in the table below:

Pin MDI-X	Signals	MDI Signals
1	RD+	TD+
2	RD-	TD-
3	TD+	RD+
6	TD-	RD-

Connect one side of an Ethernet cable into any switch port and connect the other side to your attached device. The LINK LED will light up when the cable is correctly connected. Refer to the **LED Indicators** section for descriptions of each LED indicator. Always make sure that the cables between the switches and attached devices (e.g. switch, hub, or workstation) are less than 100m (328 ft) apart.

The wiring cable types are as follows:

10Base-T: 2-pair UTP/STP Cat. 3, 5e, 6 cable, EIA/TIA-568-B.2 100-ohm (up to 100m)

100Base-TX: 2-pair UTP/STP Cat. 5e, 6 cable, EIA/TIA-568-B.2 100-ohm (up to 100m)

## 2.6 Wiring the fiber port- JetNet 4006f

JetNet 4006f includes 2 100Base-FX fiber ports. The information of fiber transceiver type is indicated in the product label that stucked on the bottom side. Choosing exactly fiber cable that is suitable to the fiber transceiver will obtain best transmission performance.

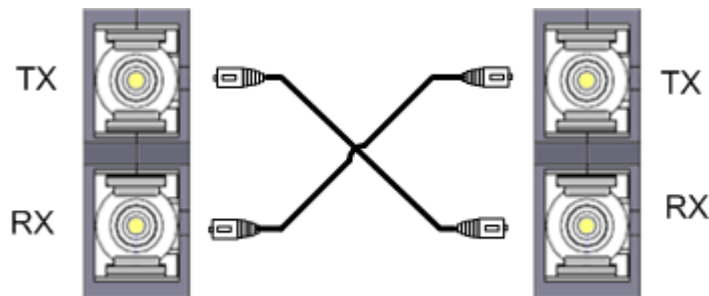

**Note:** The fiber port may adopt different type of transceiver to achieve different transmission distance and applied on different type of fiber cable. To understand and choose the suitable fiber cable, we suggest you get the specification of fiber cable from cable installer and make sure the attenuation is smaller than the power link budget of fiber transceiver the cable attached.

## 2.7 Wiring RS-232 Console Cable and pin assignment

*Korenix* includes one RS-232 DB-9 to RJ-45 cable.

1. Connect the DB-9 connector to the serial communication port ( RS-232) of your PC
2. Open Terminal tool and set up serial settings to 9600, N, 8, 1. (Baud Rate: 9600 / Parity Check: None / Data Bit: 8 / Stop Bit: 1) Then you can access the CLI interface through the console cable.

Note: If you lose the cable, please contact your sales representative to purchase a new one. The pin assignment spec is listed in the *Appendix*.

## 2.8 DIN-Rail Mounting Installation

There are 2 DIN-Rail Clips included. Each set of DIN Rail clips include 4 screws and 2 clips. If the DIN-Rail set is missing, please contact a *Korenix* distributor for help.



Use the screws provided to attach the DIN-Rail clip to the wall-mount plate of the *JetNet 4006/4006f*

## 2.9 Wall-Mount Installation

Follow the steps below to install the *JetNet 4006/4006f* wall-mount plate.

Use the hook holes located at the corners of the wall-mount plate to hang *JetNet 4006/4006f* onto a wall.

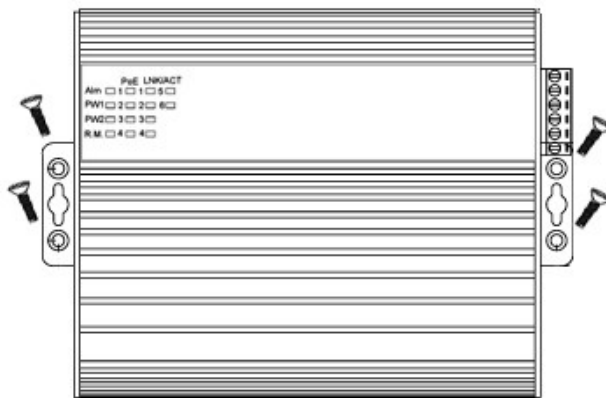

Wall-mount

## 3 Preparation for Management

The *Korenix JetNet 4006/4006f* Industrial Managed PoE Switch provides both in-band and out-band configurations.

With out-band management; you can configure the switch via RS232 console cable if you do not want to include your admin PC as part of your network. Also, in case you lose network connection, you will still be able to configure the switch via RS232 console cable. Out-band management is not affected by network performance.

In-band management allows you to remotely manage the switch via the network. You can choose Telnet or Web-based management. You just need to know the device's IP address and you can remotely connect to its embedded HTTP web pages or Telnet console.

The following topics are covered in this chapter:

### 3.1 Preparation for Serial Console

### 3.2 Preparation for Web Interface

### 3.3 Preparation for Telnet console

## 3.1 Preparation for Serial Console

In the *JetNet 4006/4006f* package, *Korenix* has included one RS-232 DB-9 to RJ-45 console cable. Attach the RS-232 DB-9 connector to your PC COM port, then connect the RJ-45 to the console port of *JetNet 4006/4006f*. If you lose the cable, please follow the console cable Pin assignment to find one (See *Appendix*).

1. Go to Start -> Program -> Accessories -> Communication -> Hyper Terminal
2. Give a name to the new console connection.
3. Choose the serial communication port.
4. Select correct serial settings. The serial settings for the *JetNet 4006/4006f* are:  
Baud Rate: 9600 / Parity Check: None / Data Bit: 8 / Stop Bit: 1
5. After connected, you will see a switch login request.
6. Login to the switch. The default username and password are **admin**.

```
Booting...
Switch login: admin
Password:

JetNet 4006 (version 2.1-20080409).
Copyright 2006-2008 Korenix Technology Co., Ltd.
Switch>
```

## 3.2 Preparation for Web Interface

The *JetNet 4006/4006f* provides HTTP Web Interface and Secure HTTPS Web Interface for web management.

### 3.2.1 Web Interface

The *Korenix* web management page uses JavaScript. This allows you to use a standard Web browser such as Microsoft Internet Explorer or Mozilla FireFox to configure the switch from anywhere while connected to the network.

Before you attempt to use the embedded web interface to manage switch operation, verify that your *JetNet 4006/4006f* Industrial Ethernet Switch is properly installed on your network and that every PC on the network can access the switch via Web browser.

1. Verify that your network interface card (NIC) is operational, and that your operating system supports TCP/IP protocol.
2. Wire the DC power to the switch and connect your switch to your computer.
3. Make sure that the switch default IP address is 192.168.10.1.
4. Change your computer IP address to 192.168.10.2 or another IP address in the 192.168.10.x subnet (Network Mask: 255.255.255.0).
5. Switch to DOS command mode and ping 192.168.10.1 to verify a normal response time.
6. Launch a web browser (Internet Explorer or Mozilla FireFox) on your PC.
7. Type **http://192.168.10.1** (or the IP address of the switch) into the Web address window. Press **Enter**.
8. Key in the username and password. The default username and password are **admin**.

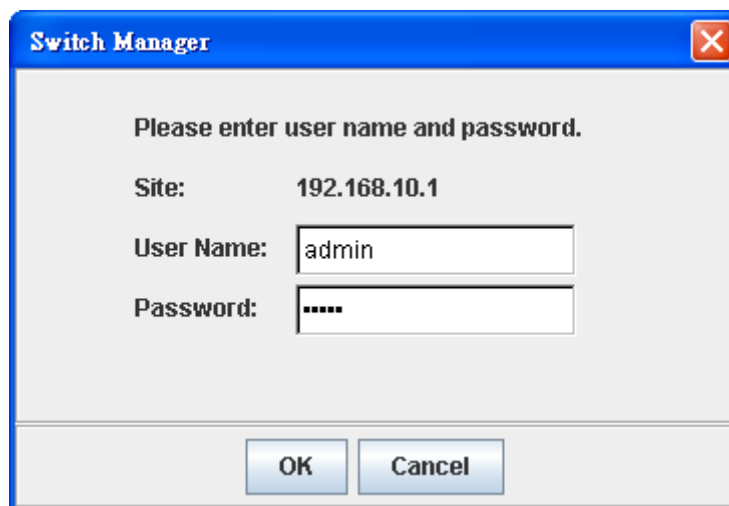

9. Click **OK**. The welcome page of the web-based management interface will now appear.

- JetNet4006
  - System
  - Basic Setting
  - Port Configuration
  - Network Redundancy
  - VLAN
  - Traffic Prioritization
  - Multicast Filtering
  - SNMP
  - Security
  - Warning
  - Monitor and Diag
    - Device Front Panel
    - Save
    - Logout

## Welcome to the JetNet4006 Industrial Managed Switch

System Name	<input type="text"/>
System Location	<input type="text"/>
System Contact	<input type="text"/>
System OID	1.3.6.1.4.1.24062.2.2.1
System Description	JetNet4006 Industrial Managed Switch
Firmware Version	v2.2.6 20090921
Device MAC	00:12:77:60:13:16

Copyright (c) 2006-2009 Korenix Technology Co., Ltd.. All Rights Reserved.

10. Once you enter the web-based management interface, you can change the *JetNet 4006/4006f*'s IP address to fit your network environment.

**Note 1:** Internet Explorer Version 5.0 or later does not allow Java applets to open sockets by default. Users must directly modify the browser settings to selectively enable Java applets in order to use network ports.

**Note 2:** The Web UI connection session of *JetNet 4006/4006f* will logout automatically if you do not input anything after 30 seconds. Re-login if this occurs.

### 3.2.2 Secured Web Interface

The *Korenix* web management page also provides a secure HTTPS login. All the configuration commands will be secure, making it hard for hackers to figure out login password and configuration commands.

1. Launch a web browser (Internet Explorer or Mozilla FireFox) on your PC.
2. Type **https://192.168.10.1** (or the IP address of the switch) into the web address window. Press **Enter**.
3. A popup screen will appear and request you to trust the secure HTTPS connection distributed by *JetNet 4006/4006f*. Press **Yes**.
4. The login screen will appear next.
5. Key in the username and password. The default username and password are **admin**.
6. Click **OK**. The welcome page of the web-based management interface will now appear.



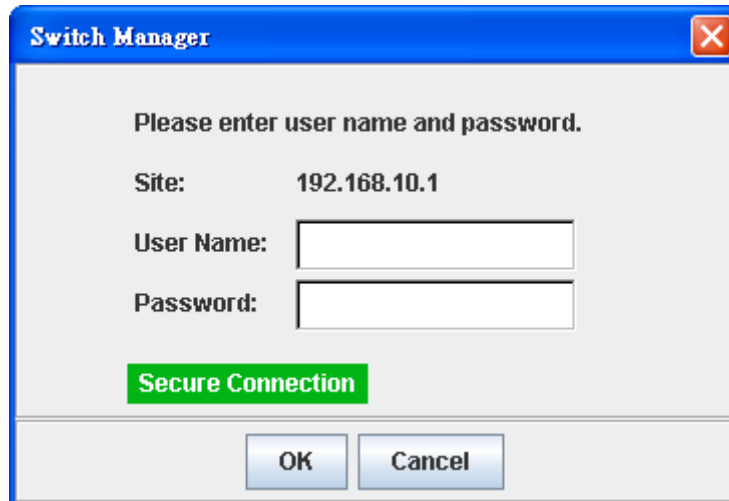

7. Once you enter the web-based management interface, all the commands you see will be the same as what appeared through HTTP login.

### 3.3 Preparation for Telnet Console

#### 3.3.1 Telnet

The *Korenix JetNet 4006/4006f* supports Telnet. You can connect to the switch through Telnet-- the command lines are the same as the RS232 console port. Below are the steps for opening a Telnet connection.

1. Go to Start -> Run -> cmd. Press **Enter**
2. Type **Telnet 192.168.10.1** (or the IP address of the switch). Press **Enter**

#### 3.3.2 SSH (Secure Shell)

The *Korenix JetNet 4006/4006f* also supports SSH. You can remotely connect to the switch by command line interface. The SSH connection can secure all the configuration commands you send to the switch.

SSH is a client/server architecture in which *JetNet 4006/4006f* is the SSH server. When you want to make a SSH connection with the switch, you should download the SSH client tool first.

##### SSH Client

There are many SSH clients you can find on the internet. For example, *PuTTY* is a free and popular Telnet/SSH client. We will use this tool to demonstrate how to log in to the *JetNet 4006/4006f* through SSH.

Note: *PuTTY*, Copyright 1997-2006 Simon Tatham.

**Download PuTTY:** <http://www.chiark.greenend.org.uk/~sgtatham/putty/download.html>

## 1. Open SSH Client (PuTTY)

In the **Session** configuration, enter the **Host Name** (IP Address of your *JetNet 4006/4006f*) and **Port number** (default = 22). Choose the **“SSH”** protocol. Then click on **“Open”** to start the SSH session console.

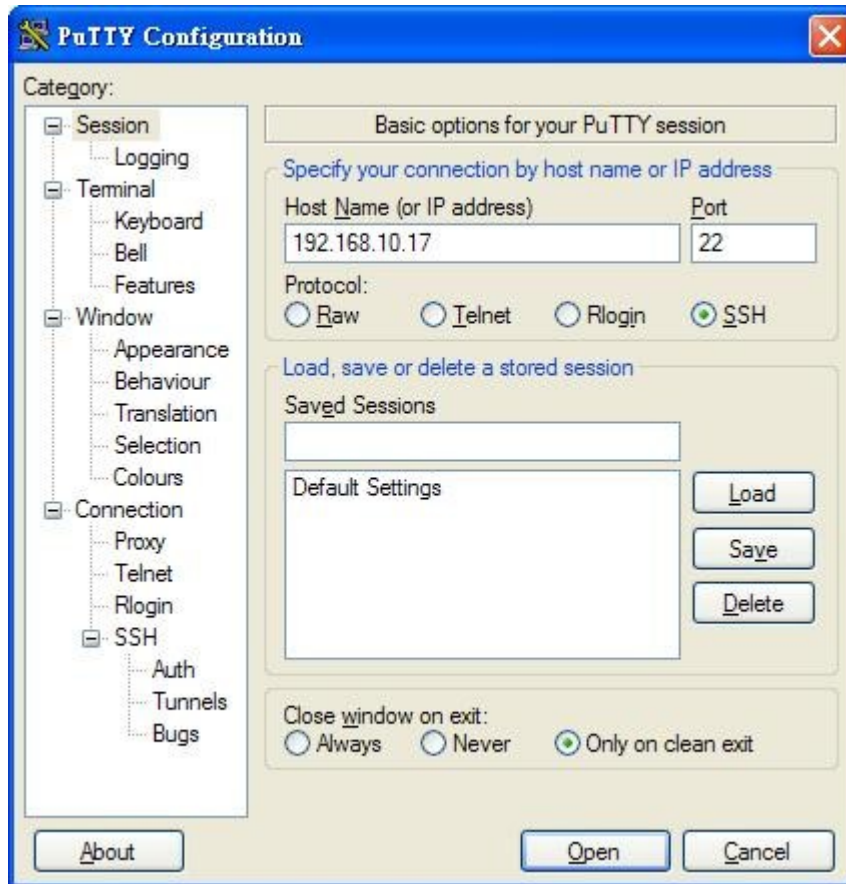

2. After clicking on **Open**, you will see the cipher information in the popup screen. Press **“Yes”** to accept the Security Alert.

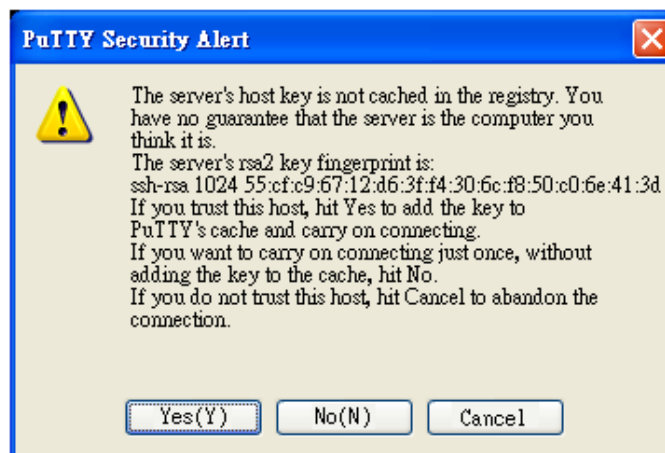

3. After a few seconds, the SSH connection to *JetNet 4006/4006f* will open.

```
login as: admin
admin@192.168.10.1's password:

JetNet4006 (version 0.0.9-20070514-14:16:45).
Copyright 2006-2010 Korenix Technology Co., Ltd.

JetNet 4006> █
```

4. Type in the login name and password. The default login name and password are **admin**.
5. All the commands you see in SSH are the same as the CLI commands you see via RS232 console. The next chapter will introduce in detail how to use the command line to configure the switch.

# 4 Feature Configuration

This chapter explains how to configure the *JetNet 4006/4006f* software and its features.

The following topics are covered in this chapter:

- 4.1 Command Line Interface (CLI) Introduction
- 4.2 Basic Settings
- 4.3 Port Configuration
- 4.4 Power over Ethernet
- 4.5 Network Redundancy
- 4.6 VLAN
- 4.7 Traffic Prioritization
- 4.8 Multicast Filtering
- 4.9 SNMP
- 4.10 Security
- 4.11 Warning
- 4.12 Monitor and Diag
- 4.13 Device Front Panel
- 4.14 Save to Flash
- 4.15 Logout

## 4.1 Command Line Interface (CLI) Introduction

The Command Line Interface (CLI) is the user interface of the switch's embedded software system. You can view the system information, see the status, configure the switch and receive a response back from the system by keying in a command.

There are different command modes. Each command mode has its own access ability, its own available command lines, and its own different command lines to enter and exit. These modes are **User EXEC, Privileged EXEC, Global Configuration, and (Port/VLAN) Interface Configuration modes**.

**User EXEC mode:** As long as you login to the switch through CLI, you will be in the User EXEC mode. You can ping, telnet remote device, and show some basic information.

Types **enable** to enter the next mode, and **exit** to logout. Below is a full command list.

Switch>	
enable	Turn on privileged mode command
exit	Exit current mode and down to previous mode
list	Print command list
ping	Send echo messages
quit	Exit current mode and down to previous mode
show	Show running system information
telnet	Open a telnet connection
traceroute	Trace route to destination

**Privileged EXEC mode:** Type **enable** in the User EXEC mode to enter the Privileged EXEC mode. In this mode, the system allows you to view current configurations, reset to default, reload the switch, show the system's information, save a configuration, and enter the global configuration mode.

You can type **configure terminal** to enter the next mode or **exit** to leave, to see a list of available command by types "?". Following diagram shows the commands.

Switch(config)# ?	
access-list	Add an access list entry
administrator	Administrator account setting
arp	Set a static ARP entry
clock	Configure time-of-day clock
default	Set a command to its defaults
end	End current mode and change to enable mode
exit	Exit current mode and down to previous mode
hostname	Set system's network name
interface	Select an interface to configure
ip	IP information
list	Print command list
log	Logging control
mac	Global MAC configuration subcommands
mac-address-table	mac address table
no	Negate a command or set its defaults
ntp	Configure NTP
password	Assign the terminal connection password
qos	Quality of Service (QoS)
relay	relay output type information
rmon	Remote monitoring
router	Enable a routing process
smtp-server	SMTP server configuration

**Global Configuration mode:** Type **configure terminal** in privileged EXEC mode. You can then enter the global configuration mode. In global configuration mode, you can configure all the features that the system provides.

Type **interface IFNAME/VLAN** to enter interface configuration mode and **exit** to leave, or **?** for command list.

Available commands for global configuration mode are shown below.

Switch#	configure terminal	
Switch(config)#		
access-list		Add an access list entry
administrator		Administrator account setting
arp		Set a static ARP entry
clock		Configure time-of-day clock
default		Set a command to its defaults
end		End current mode and change to enable mode
exit		Exit current mode and down to previous mode
hostname		Set system's network name
interface		Select an interface to configure
ip		IP information
list		Print command list
log		Logging control
mac		Global MAC configuration subcommands
mac-address-table		mac address table
multiple-super-ring		Configure Multiple Super Ring
no		Negate a command or set its defaults
ntp		Configure NTP
password		Assign the terminal connection password
qos		Quality of Service (QoS)
relay		relay output type information
rmon		Remote monitoring
router		Enable a routing process

**(Port) Interface Configuration:** Type **interface IFNAME** in global configuration mode. You can then enter interface configuration mode. In this mode, you can configure port settings.

The port interface name for fast Ethernet port 1 is fa1; fast Ethernet 6 is fa6. You can type the interface name accordingly when you want to enter a specific interface configuration mode.

You can type **exit** to leave or **“?”** for a list of available commands.

Below are the available commands for port interface configuration mode.

Switch(config)# interface fa2	
Switch(config-if)#	
auto-negotiation	Enables auto-negotiation state of a given port
description	Interface specific description
duplex	Specifies the duplex mode of operation for a port
end	End current mode and change to enable mode
exit	Exit current mode and down to previous mode
flowcontrol	Sets the flow-control value for an interface
list	Print command list
loopback	Specifies the loopback mode of operation for a port
mac	MAC interface commands
mdix	Enables mdix state of a given port
no	Negate a command or set its defaults
poe	Configure power over ethernet
qos	Quality of Service (QoS)
quit	Exit current mode and down to previous mode
rate-limit	Rate limit configuration
shutdown	Shutdown the selected interface
spanning-tree	the spanning-tree protocol
speed	Specifies the speed of a Fast Ethernet port.
switchport	Set switching mode characteristics

**(VLAN) Interface Configuration:** Type **interface VLAN VLAN-ID** in global configuration mode. You can then enter the VLAN interface configuration mode. In this mode, you can configure the settings for a specific VLAN.

The VLAN interface name for VLAN 1 is VLAN 1; VLAN 2 is VLAN 2.

You can type **exit** to leave or “?” for a list of available commands.

Available commands for the VLAN interface configuration mode appear below.

Switch(config)# interface vlan 1	
JetNet 4006 (config-if)#	
description	Interface specific description
end	End current mode and change to enable mode
exit	Exit current mode and down to previous mode
ip	Interface Internet Protocol config commands
list	Print command list
no	Negate a command or set its defaults
quit	Exit current mode and down to previous mode
shutdown	Shutdown the selected interface

The following is a summary of command modes.

Command Mode	Main Function	Enter and Exit Method	Prompt
User EXEC	This is the first level of access. Users can ping, telnet remote device, and show basic information	Enter: Type <b>login</b> to login Exit: Type <b>exit</b> to logout Next mode: Type <b>enable</b> to enter privileged EXEC mode.	Switch>
Privileged EXEC	In this mode, the system allows you to view current configuration, reset to default, reload the switch, show the system's information, save a configuration, and enter global configuration mode.	Enter: Type <b>enable</b> in User EXEC mode. Exec: Type <b>disable</b> to exit to user EXEC mode. Type <b>exit</b> to logout Next Mode: Type <b>configure terminal</b> to enter global configuration command.	Switch#
Global configuration	In global configuration mode, you can configure all the features that the system provides	Enter: Type <b>configure terminal</b> in privileged EXEC mode Exit: Type <b>exit</b> or <b>end</b> or press <b>Ctrl-Z</b> to exit. Next mode: Type <b>interface IFNAME/ VLAN VID</b> to enter interface configuration mode	Switch(config)#
Port Interface configuration	In this mode, you can configure port-related settings.	Enter: Type <b>interface IFNAME</b> in global configuration mode. Exit: Type <b>exit</b> or <b>Ctrl+Z</b> to global configuration mode. Type <b>end</b> to privileged EXEC mode.	Switch(config-if)#
VLAN Interface Configuration	In this mode, you can configure settings for specific VLAN.	Enter: Type <b>interface VLAN VID</b> in global configuration mode. Exit: Type <b>exit</b> or <b>Ctrl+Z</b> to global configuration mode. Type <b>end</b> to privileged EXEC mode.	Switch(config-vlan)#



Here are some useful commands for you to see all or specific commands available to you. Save time and avoid typing errors.

? Shows all the available commands in the mode you are currently in. It also shows you the next command you can/should type.

```
Switch(config)# interface (?)
IFNAME          Interface's name
vlan            Select a vlan to configure
```

(Character)? Shows all the available commands for what you input as "Character."

```
Switch(config)# a?
access-list      Add an access list entry
administrator    Administrator account setting
arp              Set a static ARP entry
```

**Tab Key** Helps you input commands quicker. If there is only one available command, hitting the tab key can help you automatically generate the command.

```
Switch# co (tab) (tab)
Switch# configure terminal

Switch(config)# ac (tab)
Switch(config)# access-list
```

Ctrl+C Stops an unfinished command.

Ctrl+S Locks the screen of the terminal. You will not be able to input a command.

Ctrl+Q Unlocks a locked screen.

Ctrl+Z Exits configuration mode.

An alert message appears when multiple users try to configure the switch. If the administrator is in configuration mode, then Web users will not be able to change the settings. *JetNet 4006/4006f* only allows one administrator at a time to configure the switch.

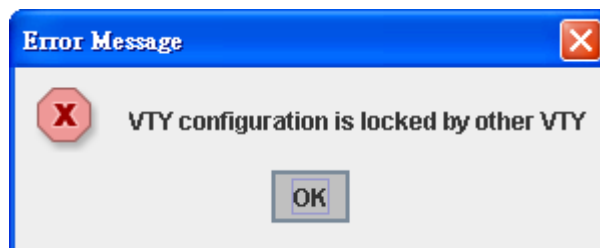

## 4.2 Basic Settings

This section provides you with instructions on how to configure switch information, set the IP address, and configure the username and password of the system. It also allows you to upgrade the firmware, backup and restore a configuration, reload the system to factory default, and reboot the system.

The following is included in this section:

- 4.2.1 Switch Setting
- 4.2.2 Admin Password
- 4.2.3 IP Configuration
- 4.2.4 Time Setting
- 4.2.5 DHCP Server
- 4.2.6 Backup and Restore
- 4.2.7 Firmware Upgrade
- 4.2.8 Factory Default
- 4.2.9 System Reboot
- 4.2.10 CLI Commands for Basic Settings

### 4.2.1 Switch Setting

You can assign a System name, Location, Contact and view the system information.

The following figure is the Web UI for Switch Setting.

System Name	JetNet 4006
System Location	
System Contact	
System OID	1.3.6.1.4.1.24062.2.2.1
System Description	JetNet4006 Industrial Managed Switch
Firmware Version	v2.2.6 20090921
Device MAC	00:12:77:60:13:16

**Apply**

**System Name:** Assign a name to the device. You can input up to 64 characters.

After you configure the name, the CLIP system will select the first 12 characters as the name for the CLIP system.

**System Location:** Specify the switch's physical location. You can input up to 64 characters.

**System Contact:** Specify contact people. Enter the name, e-mail address or other information about the administrator. You can input up to 64 characters.

**System OID:** Set the SNMP object ID of the switch. You can follow the path to find its private MIB in the MIB browser. **Note:** When you attempt to view a private MIB, you should compile private MIB files into your MIB browser first.

**System Description:** View a description of the system. *JetNet 4006/4006f* Industrial Management Ethernet Switch is the name of this device.

**Firmware Version:** Display the firmware version installed on this device.

**MAC Address:** Display the unique hardware address (MAC address) assigned by the manufacturer.

Once you have finished the configuration, click the **Apply** button to apply your settings.

**Note:** Always remember to select **Save** to save your settings. Otherwise, the settings you made will be lost when the switch is powered off.

#### 4.2.2 Admin Password

You can change the username and password to enhance security

The following figure is the Web UI for Admin Password

### Admin Password

Name	admin
Password	*****
Confirm Password	*****

**Apply**

**Username:** Key in a new username. The default setting is **admin**.

**Password:** Key in a new password. The default setting is **admin**.

**Confirm Password:** Re-enter the new password to confirm it.

Once you finish configuring the settings, click the **Apply** button to apply your configuration.

The following figure is the popup alert window when the incorrect username is entered.

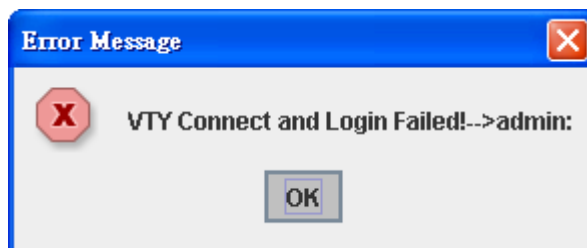

### 4.2.3 IP Configuration

This function allows users to configure the switch's IP address settings.

## IP Configuration

**DHCP Client**

IP Address	192.168.10.1
Subnet Mask	255.255.255.0
Default Gateway	192.168.10.254

**DHCP Client:** **Enable** or **Disable** DHCP Client function. When DHCP Client function is enabled, an IP address will be assigned to the switch from the network's DHCP server. In this mode, the default IP address will be replaced by the one assigned by the DHCP server. If DHCP Client is disabled, then the IP address that you specified will be used instead.

**IP Address:** You can assign the IP address reserved by your network for your *JetNet*. If DHCP Client function is enabled, you don't need to assign an IP address, as it will be overwritten by the DHCP server. The default IP address is 192.168.10.1.

**Subnet Mask:** Assign the subnet mask for the IP address. If DHCP Client function is enabled, you don't need to assign the subnet mask. The default Subnet Mask is 255.255.255.0. **Note:** In the CLI, we use the enabled subnet mask to represent the number displayed in the web UI. For example, 8 stands for 255.0.0.0; 16 stands for 255.255.0.0; 24 stands for 255.255.255.0.

**Gateway:** Assign the gateway for the switch. The default gateway is 192.168.10.254. **Note:** In the CLI, we use 0.0.0.0/0 to represent the default gateway.

Once you finish configuring the settings, click the **Apply** button to apply your configuration.

### 4.2.4 Time Setting

Time Setting source allow user to set the time by manually or through NTP server. It also provide time synchronize from PC. Network Time Protocol (NTP) is used to synchronize computer clocks on the internet. You can configure NTP settings here to synchronize the clocks of several switches on the network.

JetNet4006/4006f also provides Daylight Saving function.

**Manual Setting:** User can select Manual setting to change time as user want and also click the icon “Get Time From PC” to sync time from your PC.

**NTP client:** Select the Time Setting Source to NTP client can let device enable the NTP client.It allow JetNet 4006/4006f get time from 2 different NTP servers. The system will send request packet to acquire current time from the NTP server.

<b>Time Setting Source</b>	NTP Client
NTP Client	Manual Setting
Primary Server Address	NTP Client
	192.168.10.120
Secondary Server Address	192.168.10.121



**Time zone:** Select the time zone where the switch is located. For your reference, the following table lists the time zones of different locations. The default time zone is GMT (Greenwich Mean Time).

Switch(config)#	clock	timezone
01	(GMT-12:00)	Eniwetok, Kwajalein
02	(GMT-11:00)	Midway Island, Samoa
03	(GMT-10:00)	Hawaii
04	(GMT-09:00)	Alaska
05	(GMT-08:00)	Pacific Time (US & Canada) , Tijuana
06	(GMT-07:00)	Arizona
07	(GMT-07:00)	Mountain Time (US & Canada)
08	(GMT-06:00)	Central America
09	(GMT-06:00)	Central Time (US & Canada)
10	(GMT-06:00)	Mexico City
11	(GMT-06:00)	Saskatchewan
12	(GMT-05:00)	Bogota, Lima, Quito
13	(GMT-05:00)	Eastern Time (US & Canada)
14	(GMT-05:00)	Indiana (East)
15	(GMT-04:00)	Atlantic Time (Canada)
16	(GMT-04:00)	Caracas, La Paz
17	(GMT-04:00)	Santiago
18	(GMT-03:00)	Newfoundland
19	(GMT-03:00)	Brasilia
20	(GMT-03:00)	Buenos Aires, Georgetown
21	(GMT-03:00)	Greenland
22	(GMT-02:00)	Mid-Atlantic
23	(GMT-01:00)	Azores
24	(GMT-01:00)	Cape Verde Is.
25	(GMT)	Casablanca, Monrovia
26	(GMT)	Greenwich Mean Time: Dublin, Edinburgh, Lisbon, London
27	(GMT+01:00)	Amsterdam, Berlin, Bern, Rome, Stockholm, Vienna
28	(GMT+01:00)	Belgrade, Bratislava, Budapest, Ljubljana, Prague
29	(GMT+01:00)	Brussels, Copenhagen, Madrid, Paris
30	(GMT+01:00)	Sarajevo, Skopje, Sofija, Vilnius, Warsaw, Zagreb
31	(GMT+01:00)	West Central Africa
32	(GMT+02:00)	Athens, Istanbul, Minsk
33	(GMT+02:00)	Bucharest
34	(GMT+02:00)	Cairo
35	(GMT+02:00)	Harare, Pretoria
36	(GMT+02:00)	Helsinki, Riga, Tallinn
37	(GMT+02:00)	Jerusalem
38	(GMT+03:00)	Baghdad
39	(GMT+03:00)	Kuwait, Riyadh
40	(GMT+03:00)	Moscow, St. Petersburg, Volgograd
41	(GMT+03:00)	Nairobi
42	(GMT+03:30)	Tehran
43	(GMT+04:00)	Abu Dhabi, Muscat
44	(GMT+04:00)	Baku, Tbilisi, Yerevan
45	(GMT+04:30)	Kabul
46	(GMT+05:00)	Ekaterinburg
47	(GMT+05:00)	Islamabad, Karachi, Tashkent
48	(GMT+05:30)	Calcutta, Chennai, Mumbai, New Delhi
49	(GMT+05:45)	Kathmandu
50	(GMT+06:00)	Almaty, Novosibirsk

- 51 (GMT+06:00) Astana, Dhaka
- 52 (GMT+06:00) Sri Jayawardenepura
- 53 (GMT+06:30) Rangoon
- 54 (GMT+07:00) Bangkok, Hanoi, Jakarta
- 55 (GMT+07:00) Krasnoyarsk
- 56 (GMT+08:00) Beijing, Chongqing, Hong Kong, Urumqi
- 57 (GMT+08:00) Irkutsk, Ulaan Bataar
- 58 (GMT+08:00) Kuala Lumpur, Singapore
- 59 (GMT+08:00) Perth
- 60 (GMT+08:00) Taipei
- 61 (GMT+09:00) Osaka, Sapporo, Tokyo
- 62 (GMT+09:00) Seoul
- 63 (GMT+09:00) Yakutsk
- 64 (GMT+09:30) Adelaide
- 65 (GMT+09:30) Darwin
- 66 (GMT+10:00) Brisbane
- 67 (GMT+10:00) Canberra, Melbourne, Sydney
- 68 (GMT+10:00) Guam, Port Moresby
- 69 (GMT+10:00) Hobart
- 70 (GMT+10:00) Vladivostok
- 71 (GMT+11:00) Magadan, Solomon Is., New Caledonia
- 72 (GMT+12:00) Auckland, Wellington
- 73 (GMT+12:00) Fiji, Kamchatka, Marshall Is.
- 74 (GMT+13:00) Nuku'alofa

**Daylight Saving Time:** Set when Enable Daylight Saving Time start and end, During the Daylight Saving Time, the device's time is one hour earlier than the actual time.

<input type="checkbox"/> <b>Daylight Saving Time</b>					
Daylight Saving Start	Jan	▼	01	▼	, 00 ▼ : 00 ▼
Daylight Saving End	Jan	▼	01	▼	, 00 ▼ : 00 ▼

Once you have finished the configuration, click the **Apply** button to apply your configuration.

#### 4.2.5 DHCP Server

You can select to **Enable** or **Disable** DHCP Server function. *JetNet switch* will assign a new IP address to link partners.

#### DHCP Server configuration

After selecting to enable DHCP Server function, type in the Network IP address for the DHCP server IP pool, Subnet Mask, Default Gateway address and Lease Time for client.

**DHCP Server** Enable ▼

#### DHCP Server Configuration

Network	<input style="width: 100%;" type="text" value="192.168.10.0"/>
Subnet Mask	<input style="width: 100%;" type="text" value="255.255.255.0"/>
Default Gateway	<input style="width: 100%;" type="text" value="192.168.10.1"/>
Lease Time(s)	<input style="width: 100%;" type="text" value="604800"/>

**Apply**

Once you have finished the configuration, click the **Apply** button to apply your configuration

### Excluded Address:

You can type a specific address into the **IP Address field** for the DHCP server reserved IP address.

The IP address that is listed in the **Excluded Address List Table** will not be assigned to the network device. Add or remove an IP address from the **Excluded Address List** by clicking the **Add** or **Remove** button.

### Excluded Address

IP Address

**Add**

### Excluded Address List

Index	IP Address
1	192.168.10.200

**Remove**

**Manual Binding:** *JetNet 4006/4006f* provides a MAC address and IP address binding and removing function. You can type in the specified IP and MAC address, and then click the **Add** button to add a new MAC&IP address binding rule for a specified link partner, like PLC or any device without **DHCP client** function. To remove from the binding list, just select the rule to remove and click the **Remove** button.

### Manual Binding

IP Address

MAC Address

**Add**

### Manual Binding List



**DHCP Leased Entries:** *JetNet Switch* provides an assigned IP address list for user check. It will show the MAC and IP address that was assigned by *JetNet 4006/4006f*. Click the **Reload** button to refresh the listing.

Your Industrial Computing & Networking Partner

## DHCP Leased Entries

Index	Binding	IP Address	MAC Address	Lease Time(s)
1	Auto	192.168.0.3	0012.77ff.0530	604785

**Reload**

### 4.2.6 Backup and Restore

With the Backup command, you can save current configuration files saved in the switch's flash to the admin PC or TFTP server. This will allow you to go to the **Restore** command later, in order to restore the configuration file back to the switch. Before you restore the configuration file, you must place the backup configuration file into the PC or TFTP server. The switch will then download this file back to the flash.

There are 2 modes for users to backup/restore the configuration file, Local File mode and TFTP Server mode.

**Local File mode:** In this mode, the switch acts as the file server. Users can browse the target folder and then type in the file name to backup the configuration. Users can also

browse the target folder and select existing configuration files to restore the configuration back to the switch. This mode is only provided by Web UI; CLI is not supported.

**TFTP Server mode:** In this mode, the switch acts as TFTP client. Before you do so, make sure that your TFTP server is ready. Then type in the IP address of the TFTP Server. The system uses the default configuration file name, **Quagga.conf**. You do not need to enter a new file name. This mode can be used in both Web UI and CLI.

**TFTP Server IP Address:** Key in the IP address of your TFTP Server here.

**Backup/Restore File Name:** The system uses a default file name.

**Configuration File:** The configuration file of the switch is a text file. You can open it with *Microsoft Word* or any program that can read .txt files, modify the file, add/remove configuration settings, and then restore it back on to the switch.

**Startup Configuration File:** After you have saved the running-config to flash, the new settings will be updated after a power cycle. You can use **show startup-config** to view it in the CLI. The Backup command can only backup such configuration files to your PC or TFTP server.

**Technical Tip:**

**Default Configuration File:** The switch provides the default configuration file in the system. You can use the Reset button, Reload command to reset the system.

**Running Configuration File:** The switch's CLI allows you to view the latest settings running on the system. The information shown here are the settings you set up but have not saved to flash. The settings not yet saved to flash will not work after a power cycle. You can use **show running-config** to view it in the CLI.

The following figure is the Main UI for Backup & Restore

## Backup & Restore

**Backup Configuration** Local File ▼

Backup File Name D:\TFTP\backup.conf 

Backup

**Restore Configuration** TFTP Server ▼

TFTP Server IP 192.168.10.100

Restore File Name backup.conf

Restore

The following figure is the WEB UI for Backup/Restore Configuration - Local File mode.

**Backup Configuration** Local File ▼

Backup File Name D:\TFTP\backup.conf 

Backup



Click on the Folder icon to select the target file you want to backup/restore.

**Note:** The folders of the path to the target file do not allow you to input space key.

The following figure is the Web UI for Backup/Restore Configuration - TFTP Server mode

**Backup Configuration** TFTP Server ▼

TFTP Server IP 192.168.0.100

Backup File Name backup.conf

Backup

Type-in the IP address of TFTP Server IP. Then click the **Backup/Restore** button.

#### 4.2.7 Firmware Upgrade

In this section, you can update the switch with the latest firmware. *Korenix* provides the latest firmware on their Web site ([www.korenix.com](http://www.korenix.com)). New firmware may include new features, bug fixes or other software changes. The Web site also provides release notes for the update as well. We suggest you use the latest firmware *before* installing the switch.

**Note:** The system will automatically reboot after you finish upgrading the new firmware. Please inform all attached users before doing this.

The following figure is the Web Main UI for Firmware Upgrade.

### Firmware Upgrade

System Firmware Version: v0.0.9

System Firmware Date: 20070514

**Firmware Upgrade** Local File ▼

Firmware File Name J.8\JetNet4706-v0.0.8.bin 

Note: When firmware upgrade is finished, the switch will restart automatically.

Upgrade

There are 2 modes for users to backup/restore the configuration file, Local File mode and TFTP Server mode.

**Local File** mode: In this mode, the switch acts as the file server. Users can browse the

target folder and then type in the file name to backup the configuration. Users can also browse the target folder and select the existing configuration file to restore the configuration back to the switch. This mode is only provided by Web UI; CLI is not supported.

**TFTP Server mode:** In this mode, the switch acts as the TFTP client. Before you do so, make sure that your TFTP server is ready. Then, type in the TFTP Server IP address. This mode can be used in both Web UI and CLI.

**TFTP Server IP Address:** Key in the IP address of your TFTP Server here.

**Firmware File Name:** View the file name of the new firmware.

The UI also shows you the latest firmware version and build date. Please check the version number after you reboot the switch.

The following Web UI is for Firmware Upgrade - Local File mode.

## Firmware Upgrade

System Firmware Version: v0.0.9  
System Firmware Date: 20070514

**Firmware Upgrade** Local File

Firmware File Name  

Note: When firmware upgrade is finished, the switch will restart automatically.

**Upgrade**



Click on the Folder icon to select the correct firmware you want to upgrade

The following Web UI is for Firmware Upgrade – TFTP Server mode.

## Firmware Upgrade

System Firmware Version: v0.0.9  
System Firmware Date: 20070514

**Firmware Upgrade** TFTP Server

TFTP Server IP

Firmware File Name

Note: When firmware upgrade is finished, the switch will restart automatically.

**Upgrade**

Type in the IP address of the TFTP Server and the Firmware File Name. Then click the **Upgrade** button to start the process.

After finishing the transmission of the firmware, the system will copy the firmware file and replace the firmware in the flash. The CLI will show until the process is finished.

## 4.2.8 Factory Default

By clicking the **Reset** button, the system will reset all configurations except the IP address to its default settings. The system will show you a popup message window after running this command. Default settings will be in effect after rebooting the switch.

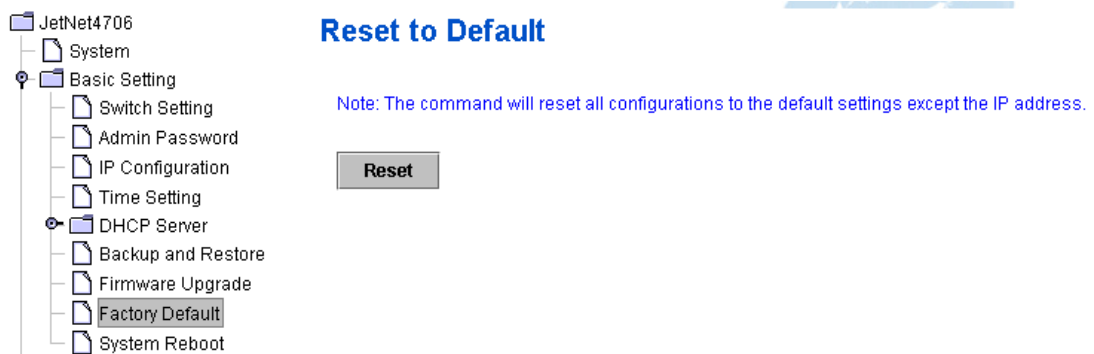

The Web UI figure for Reset to Default

### Factory Default

The following figure is the popup alert screen to confirm the command. Click **Yes** to reset the system.

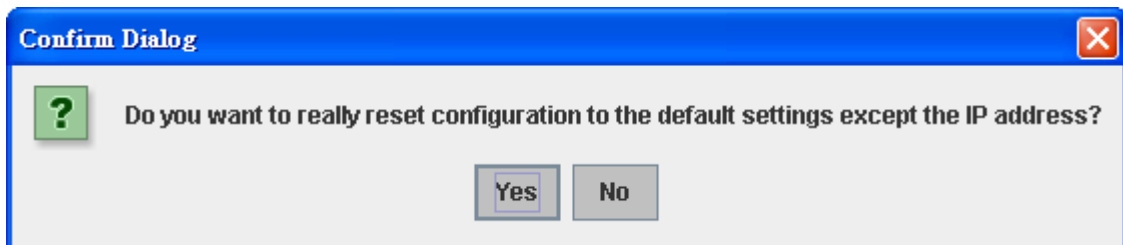

The following UI is a popup message screen to show you that the reset is complete. Click **OK** to close the screen. Then go to the **Reboot** page to reboot the switch.

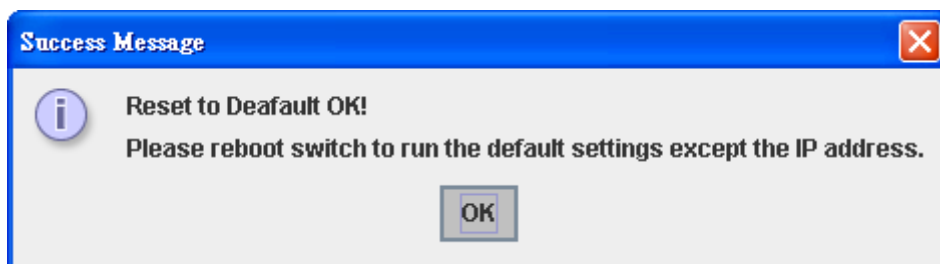

Click **OK**. The system will then automatically reboot the device.

**Note:** If you have already configured the IP of your device to another IP address; when you use this command through CLI and Web UI, our software will not reset the IP address to the default IP. The system will maintain the IP address so that you can still connect to the switch via the network.

## 4.2.9 System Reboot

System Reboot allows you to reboot the device. Some of the feature changes require you to reboot the system. Click the **Reboot** button to reboot your device.

**Note:** Remember to click the **Save** button to save your settings. Otherwise, the settings you made will be gone once the switch is powered off.

Below is the Main screen for Reboot

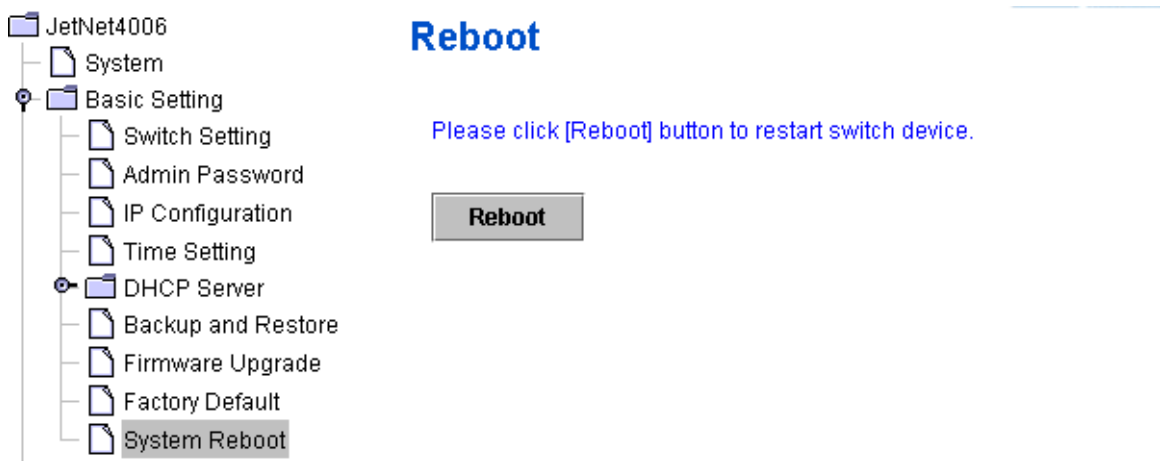

Below is the popup alert screen to request confirmation for the Switch Reboot. Click **Yes** to reboot the switch.

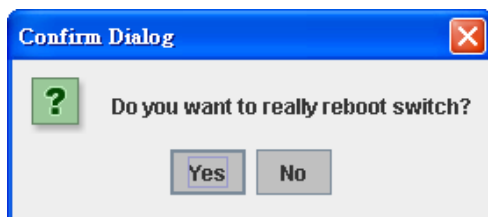

The popup message screen below appears when rebooting the switch.

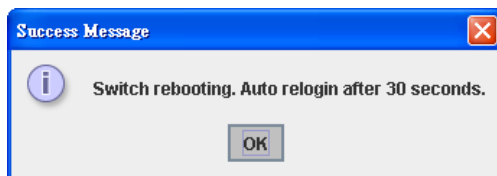

## 4.2.10 CLI Commands for Basic Settings

Feature	Command Line
<b>Switch Setting</b>	
System Name	Switch(config)# hostname WORD Network name of this system Switch(config)# hostname JetNet 4706 Switch(config)#
System Location	Switch(config)# snmp-server location Taipei
System Contact	Switch(config)# snmp-server contact korecare@korenix.com
Display	Switch# show snmp-server name JetNet 4006  Switch# show snmp-server location Taipei  Switch# show snmp-server contact <a href="mailto:korecare@korenix.com">korecare@korenix.com</a>  Switch> show version 0.31-20061218  Switch# show hardware mac MAC Address : 00:12:77:FF:01:B0
<b>Admin Password</b>	
User Name and Password	Switch(config)# administrator NAME Administrator account name Switch(config)# administrator admin % Command incomplete. Switch(config)# administrator orwell PASSWORD Administrator account password Switch(config)# administrator orwell orwell Change administrator account orwell and password orwell success.
Display	Switch# show administrator Administrator account information name: orwell password: orwell
<b>IP Configuration</b>	
IP Address/Mask (192.168.10.8, 255.255.255.0)	Switch(config)# int vlan 1 Switch(config-if)# ip address 192.168.10.8/24
Gateway	Switch(config)# ip route 0.0.0.0/0 192.168.10.254/24
Remove Gateway	Switch(config)# no ip route 0.0.0.0/0 192.168.10.254/24
Display	Switch# show running-config ..... ! interface vlan1 ip address 192.168.10.8/24 no shutdown ! ip route 0.0.0.0/0 192.168.10.254/24 !
<b>Time Setting</b>	

NTP Server	Switch(config)# ntp peer 192.168.10.100
Time Zone	Switch(config)# clock timezone 26 Sun Jan 1 04:13:24 2006 (GMT) Greenwich Mean Time: Dublin, Edinburgh, Lisbon, London  <b>Note:</b> By typing clock timezone ?, you can see the timezone list. Then choose the number of the timezone you want to select.
Display	Switch# sh ntp associations 1 192.168.10.100 2 192.168.10.101  Switch# show clock Sun Jan 1 04:14:19 2006 (GMT) Greenwich Mean Time: Dublin, Edinburgh, Lisbon, London  Switch# show clock timezone clock timezone (26) (GMT) Greenwich Mean Time: Dublin, Edinburgh, Lisbon, London
<b>Backup and Restore</b>	
Backup Startup Configuration file	Switch# copy startup-config tftp: 192.168.10.33 Writing Configuration [OK]  <b>Note 1:</b> To backup the latest startup configuration file, you should save current settings to flash first. You can refer to 4.12 to see how to save settings to the flash. <b>Note 2:</b> 192.168.10.33 is the TFTP server's IP. Your environment may use different IP addresses. Please type target TFTP server IP in this command.
Restore Configuration	Switch# copy tftp: 192.168.10.33 startup-config
Show Startup Configuration	Switch# show startup-config
Show Running Configuration	Switch# show running-config
<b>Firmware Upgrade</b>	
Firmware Upgrade	Switch# archive download-sw /overwrite tftp 192.168.10.33 JetNet 4006.bin Firmware upgrading, don't turn off the switch! Tftping file JetNet 4006.bin Firmware upgrading ..... ..... ..... Firmware upgrade success!! Rebooting.....
<b>Factory Default</b>	
Factory Default	Switch# reload default-config file Reload OK! Switch# reboot
<b>System Reboot</b>	
Reboot	Switch# reboot



## 4.3 Port Configuration

This section shows you how to enable/disable port state, or configure port auto-negotiation, speed, duplex, flow control, rate limit control and port aggregation settings. It also allows you to view port status and aggregation information.

The following commands are covered in this section:

### 4.3.1 Port Control

### 4.3.2 Port Status

### 4.3.3 Rate Control

### 4.3.4 Command Lines for Port Configuration

#### 4.3.1 Port Control

Port Control commands allow you to enable/disable port state, or configure port auto-negotiation, speed, duplex, and flow control.

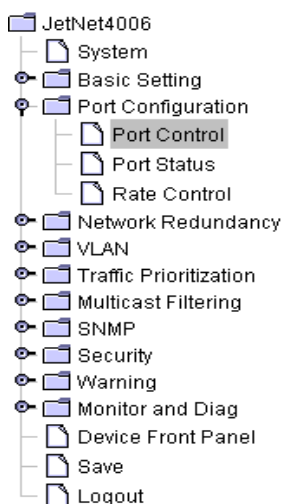

### Port Configuration

Port	State	Speed/Duplex	Flow Control
1	Enable	AutoNegotiation	Disable
2	Enable	AutoNegotiation	Disable
3	Enable	AutoNegotiation	Disable
4	Enable	AutoNegotiation	Disable
5	Enable	AutoNegotiation	Disable
6	Enable	AutoNegotiation	Disable

Apply

Select the port you want to configure and make changes to the port.

**State** column: Enable or disable the state of this port. Once you disable the port, it stops linking and forwarding traffic. The default setting when you receive the device is Enable, which means all the ports are working.

**Speed/Duplex** column: Configure the port speed and duplex mode of this port. Below are the selections you can choose:

Fast Ethernet Port 1~6 (fa1~fa6) : Auto Negotiation, 10M Full Duplex(10 Full), 10M Half Duplex(10 Half), 100M Full Duplex(100 Full) and 100M Half Duplex(100 Half).

The default mode is Auto Negotiation mode.

**Flow Control** column: Symmetric or disable the flow control function. "Symmetric" means that you need to activate the flow control function of the remote network device in order to let the flow control of that corresponding port on the switch work. "Disable" means that you do not need to activate the flow control function of the remote network device, as the flow control of that corresponding port on the switch will work either way.

Once you have finished configuring the settings, click the **Apply** button to save the configuration.

**Technical Tips:** If both ends are going at different speeds, they will not link to each other. If both ends are in different duplex modes, they will be connected by half mode.

### 4.3.2 Port Status

Port Status shows you the current port status.

## Port Status

Port	Type	Link	State	Speed/Duplex	Flow Control
1	100BASE	Down	Enable	--	Disable
2	100BASE	Down	Enable	--	Disable
3	100BASE	Down	Enable	--	Disable
4	100BASE	Down	Enable	--	Disable
5	100BASE-TX	Up	Enable	100 Full	Disable
6	100BASE	Down	Enable	--	Disable

A description of each column is as follows:

**Port:** Port interface number.

**Type:** 100BASE -> Fast Ethernet port.

**Link:** Link status. Up -> Link UP. Down -> Link Down.

**State:** Enable -> State is enabled. Disable -> The port is disabled by user configured.

**Speed/Duplex:** Current working status of the port.

**Flow Control:** The state of the flow control.

### 4.3.3 Rate Control

Rate control is a form of flow control used to enforce a strict bandwidth limit of a port. You can program separate transmitting (Egress Rule) and receiving (Ingress Rule) rate limits for each port, and even apply the limit to certain packet types as described below.

## Rate Control

### Limit Packet Type and Rate

Port	Ingress Rule		Egress Rule	
	Packet Type	Rate(Kbps)	Packet Type	Rate(Kbps)
1	Broadcast Only ▼	8192 ▼	All	no-limit ▼
2	Broadcast Only ▼	8192 ▼	All	no-limit ▼
3	Broadcast Only ▼	8192 ▼	All	no-limit ▼
4	Broadcast Only ▼	8192 ▼	All	no-limit ▼
5	Broadcast Only ▼	8192 ▼	All	no-limit ▼
6	Broadcast Only ▼	8192 ▼	All	no-limit ▼

**Apply**

**Packet type:** You can select the packet type that you want to filter. The packet types of the Ingress Rule (incoming) listed here includes **Broadcast Only**, **Broadcast/multicast**, **Broadcast/Multicast/UnknownUnicast**, and **All**. The packet types of the Egress Rule (outgoing) only support **All** packet types.

**Rate:** This column allows you to manually assign the limit rate of the port. Valid values support **128Kbps**, **256Kbps**, **512Kbps**, **1024Kbps**, **2048Kbps**, **4096Kbps** and **8192Kbps**.

To enable rate control function, please click the **Apply** button to apply the configuration.

#### 4.3.4 Command Lines for Port Configuration

Feature	Command Line
<b>Port Control</b>	
Port Control – State	<p>Switch(config-if)# shutdown -&gt; Disable port state Port1 Link Change to DOWN interface fastethernet1 is shutdown now.</p> <p>Switch(config-if)# no shutdown -&gt; Enable port state Port1 Link Change to DOWN Port1 Link Change to UP interface fastethernet1 is up now. Switch(config-if)# Port1 Link Change to UP</p>
Port Control – Auto Negotiation	<p>Switch(config)# interface fa1 Switch(config-if)# auto-negotiation Auto-negotiation of port 1 is enabled!</p>
Port Control – Force Speed/Duplex	<p>Switch(config-if)# speed 100 Port1 Link Change to DOWN set the speed mode ok! Switch(config-if)# Port1 Link Change to UP</p> <p>Switch(config-if)# duplex full Port1 Link Change to DOWN set the duplex mode ok! Switch(config-if)# Port1 Link Change to UP</p>
Port Control – Flow Control	<p>Switch(config-if)# flowcontrol on Flowcontrol on for port 1 set ok!</p> <p>Switch(config-if)# flowcontrol off Flowcontrol off for port 1 set ok!</p>
<b>Port Status</b>	
Port Status	<p>Switch# show interface fa1 Interface fastethernet1 Administrative Status : Enable Operating Status : Connected Duplex : Full Speed : 100 Flow Control :off Default Port VLAN ID: 1</p>

	<p>Ingress Filtering : Disabled          Acceptable Frame Type : All          Port Security : Disabled          Auto Negotiation : Disable          Loopback Mode : None          STP Status: forwarding          Default CoS Value for untagged packets is 0.          Mdx mode is Disable.          Medium mode is Copper.</p> <p><i>Note: Administrative Status -&gt; Port state of the port. Operating status -&gt; Current status of the port. Duplex -&gt; Duplex mode of the port. Speed -&gt; Speed mode of the port. Flow control -&gt; Flow Control status of the port.</i></p>
<b>Rate Control</b>	
Rate Control – Ingress or Egress	<p>Switch(config-if)# rate-limit              egress    Outgoing packets              ingress   Incoming packets</p> <p><b>Note: To enable rate control, you should select the Ingress or Egress rule first; then assign the packet type and bandwidth.</b></p>
Rate Control – Filter Packet Type	<p>Switch(config-if)# rate-limit ingress mode              all            Limit all frames              broadcast     Limit Broadcast frames              flooded-unicast Limit Broadcast, Multicast and flooded unicast frames              multicast     Limit Broadcast and Multicast frames</p> <p>Switch(config-if)# rate-limit ingress mode broadcast          Set the ingress limit mode broadcast ok.</p>
Rate Control - Bandwidth	<p>Switch(config-if)# rate-limit ingress bandwidth              0            0 is no limit              1024        1024 is 1024Kbps              128         128 is 128Kbps              2048        2048 is 2048Kbps              256         256 is 256Kbps              4096        4096 is 4096Kbps              512         512 is 512Kbps              8192        8192 is 8192Kbps</p> <p>Switch(config-if)# rate-limit ingress bandwidth 8192          Set the ingress rate limit to 8192k for Port 1.</p>

## 4.4 Network Redundancy

It is critical for industrial applications for networks to continue working non-stop. *JetNet 4006/4006f* supports standard RSTP, Multiple Super Ring, Rapid Dual Homing and Legacy Super Ring Client modes.

Multiple Super Ring (MSR) technology is *Korenix's* 3<sup>rd</sup> generation Ring redundancy technology. This is patented and protected by *Korenix* and is used in countries all over the world. MSR ranks the fastest restore and failover time in the world, 0 ms for restore and less than 5 milliseconds for failover.

Advanced Rapid Dual Homing technology also facilitates *JetNet 4006/4006f* to connect with a core managed switch via standard Rapid Spanning Tree Protocol. With RDH technology, you can also run RSTP to couple several Rapid Super Rings, which is also known as Auto Ring Coupling.

To become backwards compatible with the Legacy Super Ring technology implemented in *JetNet 4000/4500* switches, *JetNet 4006/4006f* also supports Super Ring Client mode. The Super Ring ports can pass through Super Ring control packets extremely well and works with Super Ring.

Besides *Korenix* ring technology, *JetNet 4006/4006f* also supports 802.1D-2004 version Rapid Spanning Tree Protocol (RSTP). The new version of RSTP standard includes 802.1D-1998 STP, 802.1w RSTP.

The following commands are included in this section:

- 4.5.1 RSTP
- 4.5.2 RSTP Information
- 4.5.3 Multiple Super Ring (MSR)
- 4.5.4 Ring Information
- 4.5.5 Command Lines for Network Redundancy

#### 4.4.1 RSTP

RSTP stands for Rapid Spanning Tree Protocol. If a switch has more than one path to a destination, it will lead to message loops that can generate broadcast storms and quickly bog down a network. The spanning tree was created to combat the negative effects of message loops in switched networks. A spanning tree uses a spanning tree algorithm (STA) to automatically sense whether a switch has more than one way to communicate with a node. It will then select the best path (primary), and block the other path(s). It will also keep track of the blocked path(s) in case the primary path fails. Spanning Tree Protocol (STP) introduced a standard method to accomplish this. It is specified in IEEE 802.1D-1998. Later, Rapid Spanning Tree Protocol (RSTP) was adopted and represents the evolution of STP, providing for a much faster spanning tree convergence after a topology change. This is specified in IEEE 802.1w. In 2004, 802.1w was included into the 802.1D-2004 version. This switch supports both RSTP and STP (all switches that supports RSTP are also backwards compatible with switches that support only STP).

This page allows you to enable/disable RSTP, and configure the global setting and port settings.

Help

**Your Industrial Computing & Networking Partner**

### Rapid Spanning Tree Protocol

- JetNet4006
  - System
  - Basic Setting
  - Port Configuration
  - Network Redundancy
    - RSTP**
    - RSTP Information
    - Multiple Super Ring
    - Multiple Super Ring Inform
  - VLAN
  - Traffic Prioritization
  - Multicast Filtering
  - SNMP
  - Security
  - Warning
  - Monitor and Diag
  - Device Front Panel
  - Save
  - Logout

**RSTP**
Disable ▾

#### Bridge Configuration

Priority	32768 ▾
Max Age(6-40 sec)	<input type="text"/>
Hello Time(1-10 sec)	<input type="text"/>
Forward Delay(4-30 sec)	<input type="text"/>

#### Port Configuration

Port	Admin Path Cost	Priority	Admin P2P	Admin Edge
1	<input type="text"/>	128 ▾	Auto ▾	Disable ▾
2	<input type="text"/>	128 ▾	Auto ▾	Disable ▾
3	<input type="text"/>	128 ▾	Auto ▾	Disable ▾
4	<input type="text"/>	128 ▾	Auto ▾	Disable ▾
5	<input type="text"/>	128 ▾	Auto ▾	Disable ▾
6	<input type="text"/>	128 ▾	Auto ▾	Disable ▾
7	<input type="text"/>	128 ▾	Auto ▾	Disable ▾
8	<input type="text"/>	128 ▾	Auto ▾	Disable ▾
9	<input type="text"/>	128 ▾	Auto ▾	Disable ▾
10	<input type="text"/>	128 ▾	Auto ▾	Disable ▾

Apply

**RSTP Mode:** You must first enable STP/RSTP mode before configuring any related parameters. Parameter settings required for both STP and RSTP are the same. Note that 802.1d refers to STP mode, while 802.1w refers to faster RSTP mode.

### **Bridge Configuration**

**Priority (0-61440):** RSTP uses bridge ID to determine the root bridge, the bridge with the highest bridge ID becomes the root bridge. The bridge ID is composed of bridge priority and bridge MAC address. So that the bridge with the highest priority becomes the highest bridge ID. If all of the bridge IDs have the same priority, the bridge with the lowest MAC address will then become the root bridge.

**Note:** The bridge priority value must be in multiples of 4096. A device with a lower number has a higher bridge priority. Ex: 4096 is higher than 32768.

**Max Age (6-40):** Enter a value from 6 to 40 seconds here. This value represents the time that a bridge will wait without receiving Spanning Tree Protocol configuration messages before attempting to reconfigure.

If *JetNet 4006/4006f* is not the root bridge, and if it has not received a hello message from the root bridge in the amount of time equal to the Max Age, then *JetNet 4006/4006f* will reconfigure itself as a root bridge. Once two or more devices on the network are recognized as a root bridge, the devices will renegotiate to set up a new spanning tree topology.

**Hello Time (1-10):** Enter a value from 1 to 10 seconds here. This is a periodic timer that drives the switch to send out a BPDU (Bridge Protocol Data Unit) packet to check current STP status.

The root bridge of the spanning tree topology periodically sends out a “hello” message to other devices on the network to check if the topology is “healthy.” The “hello time” is the amount of time the root has waited in between sending hello messages.

**Forward Delay Time (4-30):** Enter a value between 4 and 30 seconds. This value is the time that a port waits before changing from Spanning Tree Protocol learning and listening states to forwarding state.

This is the amount of time *JetNet 4006/4006f* will wait before checking to see if it should be changed to a different state.

Once you have completed your configuration, click the **Apply** button to apply your settings.

**Note:** You must observe the following rules to configure Hello Time, Forwarding Delay, and Max Age parameters.

**$2 \times (\text{Forward Delay Time} - 1 \text{ sec}) \geq \text{Max Age Time} \geq 2 \times (\text{Hello Time value} + 1 \text{ sec})$**

### **Port Configuration**

Select the port you want to configure; you will be able to view the current settings and status of the port.

**Path Cost:** Enter a number between 1 and 200,000,000. This value represents the “cost” of the path to the other bridge from the transmitting bridge at the specified port.

**Priority:** Enter a value between 0 and 240 using multiples of 16. This is the value that decides which port should be blocked by priority in a LAN.

**Admin P2P:** Some of the rapid state transitions that are possible within RSTP depend upon whether the port of concern can only be connected to another bridge (i.e. it is served by a point-to-point LAN segment), or if it can be connected to two or more bridges (i.e. it is served by a shared-medium LAN segment). This function allows P2P status of the link to be manipulated administratively. **Auto** means to auto select P2P or Share mode. **P2P** means P2P is enabled,

while **Share** means P2P is disabled.

**Admin Edge:** A port directly connected to the end stations cannot create a bridging loop in the network. To configure this port as an edge port, set the port to the **Enable** state. When the non-bridge device connects an admin edge port, this port will be in blocking state and turn to forwarding state in 4 seconds.

Once you have finished your configuration, click the **Apply** button to save your settings.

#### 4.4.2 RSTP Information

This page allows you to see the information of the root switch and port status.

**Root Information:** You can see Root Bridge ID, Root Priority, Root Port, Root Path Cost and the Max Age, Hello Time and Forward Delay of BPDU sent from the root switch.

**Port Information:** You can see port Role, Port State, Path Cost, Port Priority, Oper P2P mode, Oper edge port mode.

**RSTP Information**

**Root Information**

Bridge ID	8000.0012.7760.1316
Root Priority	32768
Root Port	N/A
Root Path Cost	0
Max Age(6-40)	20 sec
Hello Time(1-10)	2 sec
Forward Delay(4-30)	15 sec

**Port Information**

Port	Role	Port State	Oper Path Cost	Port Priority	Oper P2P	Oper Edge
1	--	Disabled	200000	128	P2P	Edge
2	--	Disabled	200000	128	P2P	Edge
3	--	Disabled	200000	128	P2P	Edge
4	--	Disabled	200000	128	P2P	Edge
5	Designated	Forwarding	200000	128	P2P	Edge
6	--	Disabled	200000	128	P2P	Edge
7						
8						
9						
10						

**Reload**

#### 4.4.3 Multiple Super Ring (MSR)

The most common industrial network redundancy is to form a ring or loop. Typically, the managed switches are connected in a series and the last switch is connected back to the first one. In such a connection, you can use *Korenix* Super Ring and Rapid Super Ring technology.

Super Ring is *Korenix's* 1<sup>st</sup> generation ring redundancy technology released with *JetNet 4000/4500*. Rapid Super Ring (RSR) is *Korenix's* 2<sup>nd</sup> generation Ring redundancy technology. The Rapid Super Ring has an enhanced Ring Master selection and shorter recovery time. Multiple Super Ring is the 3<sup>rd</sup> *Korenix* Ring technology. It is designed for more complex ring

application and even faster recovery time. These are patented and protected by *Korenix* and is used in countries all over the world.

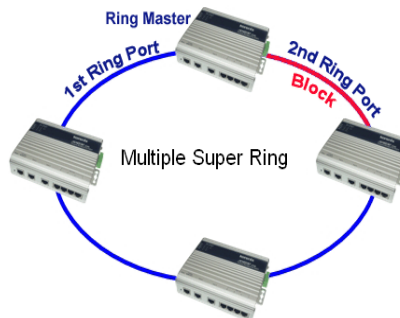

This page allows you to enable the settings for Multiple Super Ring and Rapid Dual Homing.

**New Ring:** To create a Rapid Super Ring. Just fill in the Ring ID which has a range from 0 to 31. If the name field is left blank, the name of this ring will automatically name with RingID.

### New Ring

Ring ID	Name
<input type="text"/>	<input type="text"/>

### Ring Configuration

ID	Name	Version	Device Priority	Ring Port1	Path Cost	Ring Port2	Path Cost	Rapid Dual Homing	Ring Status
1	Ring1	Rapid Super ... ▼	128	Port 5	128	Port 6	128	Disable	Disable

This page allows you to enable the settings for Rapid Super Ring.

#### Ring Configuration

**ID:** Once a Ring is created, This appears and can not be changed.

**Name:** This field will show the name of the Ring. If it is not filled in when creating, it will be automatically named by the rule "RingID".

**Version:** The version of Ring can be changed here. There are two modes to choose: Rapid Super Ring as default and Super ring for compatible with Korenix 1<sup>st</sup> general ring.

**Device Priority:** The switch with highest priority (highest value) will be automatically selected as



Ring Master. Then one of the ring ports in this switch will become forwarding port and the other one will become blocking port. If all of the switches have the same priority, the switch with the biggest MAC address will be selected as Ring Master.

**Ring Port1:** In Rapid Super Ring environment, you should have 2 Ring Ports. No matter this switch is Ring Master or not, when configuring RSR, 2 ports should be selected to be Ring Ports. For Ring Master, one of the ring ports will become the forwarding port and the other one will become the blocking port.

**Path Cost:** Change the Path Cost of Ring Port1. If this switch is the Ring Master of a Ring, then it determines the blocking port. The Port with higher Path Cost in the two ring Ports will become the blocking port, if the Path Cost is the same, the port with larger port number will become the blocking port.

**Ring Port2:** Assign another port for ring connection

**Path Cost:** Change the Path Cost of Ring Port2

**Rapid Dual Homing:** Rapid Dual Homing is an important feature of Korenix 3<sup>rd</sup> generation Ring redundancy technology. When you want to connect multiple RSR or form redundant topologies with other vendors, Rapid Dual Homing could allow you to have multiple links for redundancy without any problem. The maximum uplink is 7 per group.

In Dual Homing I released with JetNet 4000/4500 series, you have to configure additional port as Dual Homing port to two uplink switches. In Rapid Dual Homing, you don't need to configure specific port to connect to other protocol. The Rapid Dual Homing will smartly choose the fastest link for primary link and block all the other link to avoid loop. If the primary link failed, Rapid Dual Homing will automatically forward the secondary link for network redundant. Of course, if there are more connections, they will be standby links and recover one of them if both primary and secondary links are broken.

**Ring status:** To enable/disable the Ring. Please remember to enable the ring after you add it.

**Notice:** JetNet 4006/4006f can only create single ring.

#### 4.4.4 Ring Information

This page shows MSR information.

**ID:** Ring ID.

**Version:** which version of this ring, this field could be Rapid Super Ring or Super Ring.

**Role:** This Switch is RM or nonRM

**Status:** If this field is Normal which means the redundancy is approved. If any one of the link in this Ring is broken, then the status will be Abnormal.

**RM MAC:** The MAC address of Ring Master of this Ring. It helps to find the redundant path.

**Blocking Port:** This field shows which port of RM is blocked.

**Role Transition Count:** This means how many times this switch has changed its Role from nonRM to RM or from RM to nonRM.

**Role state Transition Count:** This number means how many times the Ring status has been transformed between Normal and Abnormal state.

## Multiple Super Ring Information

ID	Version	Role	Status	RM MAC	Blocking Port	Role Transition Count	Ring State Transition Count
1	Rapid Super Ring	RM	Abnormal	0012.7760.1316	--	2	3

Reload

### 4.4.5 Command Lines for Network Redundancy

Feature	Command Line
<b>RSTP</b>	
Enable	Switch(config)# spanning-tree enable
Disable	Switchconfig)# spanning-tree disable
RSTP mode	Switch(config)# spanning-tree mode rapid-stp Spanning Tree Mode change to be RSTP (802.1w).
STP mode	Switch(config)# spanning-tree mode stp Spanning Tree Mode change to be STP (802.1d).
Priority	Switch(config)# spanning-tree priority <0-61440> valid range is 0 to 61440 in multiple of 4096 Switch(config)# spanning-tree priority 4096
Max Age	Switch(config)# spanning-tree max-age <6-40> Valid range is 6~40 seconds Switch(config)# spanning-tree max-age 10
Hello Time	Switch(config)# spanning-tree hello-time <1-10> Valid range is 1~10 seconds Switch(config)# spanning-tree hello-time 2
Forward Delay	Switch(config)# spanning-tree forward-time <4-30> Valid range is 4~30 seconds Switch(config)# spanning-tree forward-time 15
algorithm-timer	Switch(config)# spanning-tree algorithm-timer <i>forward delay, max-age, hello time.</i> Switch(config)# spanning-tree algorithm-timer 15 20 2
Path Cost Method	Switch(config-if)# spanning-tree cost method long ->specifies 32-bit based values that range from 1-200,000,000 short ->specifies 16-bit based values that range from 1-65535 Switch(config-if)# spanning-tree cost method long
Port Priority	Switch(config-if)# spanning-tree port-priority <0-240> Number from 0 to 240, in multiple of 16 Switch(config-if)# spanning-tree port-priority 128
bpdufilter	Switch(config-if)# spanning-tree bpdufilter enable
bpduguard	Switch(config-if)# spanning-tree bpduguard enable
Link Type - Auto	Switch(config-if)# spanning-tree link-type auto
Link Type - P2P	Switch(config-if)# spanning-tree link-type point-to-point
Link Type - Share	Switch(config-if)# spanning-tree link-type shared
Edge Port	Switch(config-if)# spanning-tree edge-port enable

	Switch(config-if)# spanning-tree edge-port disable
<b>RSTP Info</b>	
Active status	<pre>Switch# show spanning-tree active Rapid Spanning-Tree feature           Enabled Spanning-Tree BPDU transmission-limit 3 Root Address    0012.7701.0386  Priority 4096 Root Path Cost : 200000          Root Port : 7 Root Times :    max-age 20 sec, hello-time 2 sec, forward-delay 15 sec Bridge Address  0012.77ff.0102  Priority 4096 Bridge Times :  max-age 10 sec, hello-time 2 sec, forward-delay 15 sec Aging time : 300  Port      Role      Port-State    Cost      Prio.Nbr    Type ----- fa6      Designated  Forwarding    200000    128.6      Auto(RST) fa7      Root        Forwarding    200000    128.7 Shared(STP)</pre>
RSTP Summary	<pre>Switch# show spanning-tree summary Switch is in rapid-stp mode. BPDU skewing detection disabled for the bridge. Backbonefast disabled for bridge. Summary of connected spanning tree ports : #Port-State Summary Blocking  Listening  Learning  Forwarding  Disabled ----- 0         0         0         2         8 #Port Link-Type Summary AutoDetected  PointToPoint  SharedLink  EdgePort ----- 9             0             1             9</pre>
Port Info	<pre>Switch# show spanning-tree port detail fa7 (Interface_ID) Rapid Spanning-Tree feature           Enabled IEEE compatible Spanning-Tree Protocol Enabled Spanning-Tree BPDU transmission-limit 3 Bridge identifier has priority 4096, address 0012.77ff.0102 Configured hello time 2, max age 10, forward delay 15 Current root has priority 4096, address 0012.7701.0386 Root port is 7 , cost of root path is 200000 Topology change flag not set, detected flag not set Number of topology changes 0, last change occurred from 0000.0000.0000 Times:  hello 2 , max age 20 , forward delay 15 Timers:  hello 0 , topology change 0  Rapid Spanning-Tree link-type : Shared Rapid Spanning-Tree edge-port : Disabled Port 128.7 as Root Role is in Forwarding State Port Path Cost 200000, Port Identifier 128.7 Designated root has priority 4096, address 0012.7701.0386 Designated bridge has priority 4096, address 0012.7701.0386 Designated Port ID is 128.1, Root Path Cost is 0 Timers :  message-age 4 sec, forward-delay 0 sec Forwarding-State Transmit count 2 BPDU: sent 624 , received 3600 TCN : sent 0 , received 0</pre>
<b>Rapid Super Ring</b>	
Create or configure a	Switch(config)# multiple-super-ring 1

Ring	<p>Ring 1 created</p> <p>Switch(config-super-ring-plus)#</p> <p><b>Note: 1 is the target Ring ID which is going to be created or configured.</b></p>
Super Ring Version	<p>Switch(config-super-ring-plus)# version</p> <p>default set default to rapid super ring</p> <p>rapid-super-ring rapid super ring</p> <p>super-ring super ring</p> <p>Switch(config-super-ring-plus)# version rapid-super-ring</p>
Priority	<p>Switch(config-super-ring-plus)# priority</p> <p>&lt;0-255&gt; valid range is 0 to 255</p> <p>default set default</p> <p>Switch(config-super-ring-plus)# priority 100</p>
Ring Port	<p>Switch(config-super-ring-plus)# port</p> <p>IFLIST Interface list, ex: fa1,fa3-5,fa8-10</p> <p>cost path cost</p> <p>Switch(config)# super-ring port fa1,fa2</p>
Ring Port Cost	<p>Switch(config-super-ring-plus)# port cost</p> <p>&lt;0-255&gt; valid range is 0 or 255</p> <p>default set default (128)valid range is 0 or 255</p> <p>Switch(config-super-ring-plus)# port cost 100</p> <p>&lt;0-255&gt; valid range is 0 or 255</p> <p>default set default (128)valid range is 0 or 255</p> <p>Switch(config-super-ring-plus)# port cost 100 200</p> <p>Set path cost success.</p>
Rapid Dual Homing	<p>Switch(config-super-ring-plus)# rapid dual-homing enable</p> <p>Switch(config-super-ring-plus)# rapid dual-homing disable</p> <p>Switch(config-super-ring-plus)# rapid dual-homing port</p> <p>IFLIST Interface name, ex: fastethernet1 or fa8</p> <p>auto-detect up link auto detection</p> <p>IFNAME Interface name, ex: fastethernet1 or fa4</p> <p>Switch(config-super-ring-plus)# rapid dual-homing port</p> <p>fa3,fa5-6</p> <p>set Dual Homing port success.</p> <p>Switch(config-multiple-super-ring)# rapid-dual-homing port fa1</p> <p>priority default</p> <p>Set Rapid Dual Homing port priority success.</p> <p>Note: auto-detect is recommended for Rapid Ddual Homing.</p> <p>Note: When configure Rapid Dual Homing port, IFNAME is used for port priority.</p>
<b>Ring Info</b>	
Ring Info	<p>Switch# show multiple-super-ring [Ring ID]</p> <p>[Ring1] Ring1</p> <p>Current Status : Disabled</p> <p>Role : Disabled</p> <p>Ring Status : Abnormal</p> <p>Ring Manager : 0000.0000.0000</p> <p>Blocking Port : N/A</p> <p>Giga Copper : N/A</p> <p>Configuration :</p> <p>Version : Rapid Super Ring</p>

	<p>Priority : 128 Ring Port : fa1, fa2 Path Cost : 100, 200 Rapid Dual Homing: Disabled Statistics : Watchdog sent 0, received 0, missed 0 Link Up sent 0, received 0 Link Down sent 0, received 0 Role Transition count 0 Ring State Transition count 1</p> <p>Ring ID is optional. If the ring ID is typed, this command will only display the information of the target Ring.</p>
--	--

## 4.5 VLAN

*JetNet 4006/4006f* supports Port-Based VLAN functionality for the purpose of limiting a broadcast domain to specific members of a group by physically grouping the members together.

*JetNet 4006/4006f* determines the membership of a data frame by examining the configuration of the port that received the transmission, or by reading a portion of the data frame's tag header. A four-byte field in the header is used to identify the VLAN. This VLAN identification indicates which VLAN the frame belongs to. If the frame has no tag header, the switch checks the VLAN setting of the port that received the frame. If the switch has been configured for port based VLAN support, it assigns the port's VLAN identification to the new frame.

The following commands are included in this section:

### 4.6.1 Management VLAN

### 4.6.2 Port Based VLAN Configuration

### 4.6.3 CLI command of Port Based VLAN

#### 4.5.1 Management VLAN

The Management VLAN ID configuration is for the *JetNet 4006/4006f* management interface security. Only the management packet with the same VLAN ID will forward to a CPU interface. You can assign an ID number from 1 to 4094, and then click the **Apply** button to assign Management VLAN ID. The following is the UI interface.

Management VLAN ID

**Apply**

#### 4.5.2 Port Based VLAN Configuration

**PVID:** The abbreviation of **Port VLAN ID**. Enter the port VLAN ID here. PVID allows the switches to identify which port belongs to which VLAN. To keep things simple, it is recommended that PVID is equivalent to VLAN IDs. The values of PVIDs are from 1 to 4094. But, 0 and 4095 are reserved. You can not input these 2 PVIDs. 1 is the default value. 2 to 4094 are valid and available in this column. Type the PVID you'd like to configure here.

**Allow Send To:** This column defines the port that traffic could be forwarded to. You can click the icon to join the port as a Port Based VLAN group. The following figure is the Web user interface for Port Based VLAN configuration.

Port	PVID	Allow to Send to						Egress Tagged/Untagged
		1	2	3	4	5	6	
1	<input type="text" value="1"/>	--	<input type="checkbox"/>	<input type="checkbox"/>	<input type="checkbox"/>	<input checked="" type="checkbox"/>	<input checked="" type="checkbox"/>	Untagged

**Egress Tagged/ Untagged:** Each port of *JetNet 4006/4006f* supports Tag modify function. It includes Untagged, Tagged or Un-modify modes. The packets egress from this port is modified according to the selected rule.

The following figure is the Web user interface for a Port Based VLAN.

## Port-Based VLAN

Management VLAN ID

**Apply**

### Port-Based VLAN

Port	PVID	Allow to Send to						Egress Tagged/Untagged
		1	2	3	4	5	6	
1	<input type="text" value="1"/>	--	<input checked="" type="checkbox"/>	<input checked="" type="checkbox"/>	<input checked="" type="checkbox"/>	<input checked="" type="checkbox"/>	<input checked="" type="checkbox"/>	Untagged
2	<input type="text" value="1"/>	<input checked="" type="checkbox"/>	--	<input checked="" type="checkbox"/>	<input checked="" type="checkbox"/>	<input checked="" type="checkbox"/>	<input checked="" type="checkbox"/>	Untagged
3	<input type="text" value="1"/>	<input checked="" type="checkbox"/>	<input checked="" type="checkbox"/>	--	<input checked="" type="checkbox"/>	<input checked="" type="checkbox"/>	<input checked="" type="checkbox"/>	Untagged
4	<input type="text" value="1"/>	<input checked="" type="checkbox"/>	<input checked="" type="checkbox"/>	<input checked="" type="checkbox"/>	--	<input checked="" type="checkbox"/>	<input checked="" type="checkbox"/>	Untagged
5	<input type="text" value="1"/>	<input checked="" type="checkbox"/>	<input checked="" type="checkbox"/>	<input checked="" type="checkbox"/>	<input checked="" type="checkbox"/>	--	<input checked="" type="checkbox"/>	Untagged
6	<input type="text" value="1"/>	<input checked="" type="checkbox"/>	<input checked="" type="checkbox"/>	<input checked="" type="checkbox"/>	<input checked="" type="checkbox"/>	<input checked="" type="checkbox"/>	--	Untagged

**Apply**

#### 4.5.3 CLI Commands of the VLAN

Command Lines of the VLAN port configuration, VLAN configuration and VLAN table display

Description	CLI Command
Displays the current port based vlan configuration for each port, which include the default PVID, the ports for forwarding, and the egress mode of the port.	<pre>show vlan ex: Switch# sh vlan Port-based vlan mode: Port PVID EgressMode          Egress Ports ----- fa1    1    Tagged fa2-3 fa2    1    Untagged fa3-4 fa3    1    Untagged fa1-2,fa4-6 fa4    1    Untagged fa1-3,fa5-6 fa5    3    Untagged fa1-4,fa6 fa6    1    Untagged fa1-5 Switch#</pre>

The ports where the frame comes in to this port are allowed to forward to.

```
switchport port-based-vlan egress-ports [IFLIST]
```

ex: port 1 can forward packet to port 2,3

```
Switch(config-if)# switchport port-based-vlan egress-ports fa2,fa3
```

Set port-based vlan success

Assign default PVID for this port

```
switchport trunk native vlan VID
```

ex: assign VID 1 to port 1

```
Switch# configure terminal
```

```
Switch(config)# interface fa1
```

```
Switch(config-if)# switchport trunk native vlan 1
```

Set port default vlan id to 1 success

```
Switch(config-if)#
```

Specify when a frame that is egressing from this port should be tagged, untagged or unmodified

```
switchport port-based-vlan mode
```

(untagged|tagged|unmodified)

ex: Egress packet of port 1 with tagged.

```
Switch(config-if)# switchport port-based-vlan mode tagged
```

Set port-based vlan mode success



## 4.6 Traffic Prioritization

Quality of Service (QoS) provides a traffic prioritization mechanism that allows users to deliver better service to certain flows. QoS can also help to alleviate congestion problems and ensure that high priority traffic is delivered first. This section allows you to configure Traffic Prioritization settings for each port in regards to setting priorities.

The *JetNet 4006/4006f* QoS supports 4 physical queues, weighted fair queuing (WRR) and Strict Priority scheme, which follows 802.1p COS tag and IPv4 TOS/DiffServ information to prioritize the traffic of your industrial network.

The following commands are explained in this section:

### 4.7.1 QoS Setting

### 4.7.2 CoS-Queue Mapping

### 4.7.3 DSCP-Queue Mapping

### 4.7.4 CLI Commands for Traffic Prioritization

### 4.6.1 QoS Setting

## QoS Setting

### Queue Scheduling

- Use an 8,4,2,1 weighted fair queuing scheme
- Use a strict priority scheme

### Port Setting

Port	Priority	Trust Mode
1	0 ▼	COS Only ▼
2	0 ▼	COS Only ▼
3	0 ▼	COS Only ▼
4	0 ▼	COS Only ▼
5	0 ▼	COS Only ▼
6	0 ▼	COS Only ▼

Apply

### Queue Scheduling

**Use an 8,4,2,1 weighted fair queuing scheme.** This is also known as **WRR** (Weight Round Robin). JetNet will follow the 8:4:2:1 rate to process the packets in a queue from the highest priority to the lowest. For example, the system will simultaneously process 8 packets with the highest priority in the queue, 4 packets with middle priority, 2 packets with low priority, and 1 packet with the lowest priority.

**Use a strict priority scheme.** Packets with the highest priority in the queue will always be processed first.

### Port Setting

The **Priority** column is to indicate the default port priority value for untagged or priority-tagged frames. When *JetNet 4006/4006f* receives the frames, *JetNet 4006/4006f* will assign the value to the priority. You can enable 0,1,2 or 3 to the port. The priority is directly mapping to queue id, queue 3 is the highest priority queue.

**Trust Mode:** This indicates Queue Mapping types for you to select.

**CoS Only:** Port priority will only follow CoS-Queue Mapping that you have assigned.

**DSCP Only:** Port priority will only follow DSCP-Queue Mapping that you have assigned.

**CoS first:** Port priority will follow CoS-Queue Mapping first, and then DSCP-Queue Mapping rule.

**DSCP first:** Port priority will follow DSCP-Queue Mapping first, and then CoS-Queue Mapping rule.

**Port Based:** The port priority will follow the queue priority that you have assigned.

The default priority type is **CoS Only**. The system will provide a default CoS-Queue table that you can refer to for the next command.

After configuring, click the **Apply** button to enable the settings.

## 4.6.2 CoS-Queue Mapping

This area is where the user can set CoS values to the Physical Queue mapping table. Since the switch fabric of *JetNet 4006/4006f* supports 4 physical queues (Lowest, Low, Middle and High), users should assign CoS value to the level of the physical queue.

With the *JetNet 4006/4006f* users can easily assign the mapping table or follow suggestions from the 802.1p standard. *Korenix* uses 802.p standards for its default values. You will find that the CoS values 1 and 2 are mapped to physical Queue 0 (lowest queue). CoS values 0 and 3 are mapped to physical Queue 1, (low/normal physical queue), CoS values 4 and 5 are mapped to physical Queue 2 (middle physical queue), and CoS values 6 and 7 are mapped to physical Queue 3 (highest physical queue).

### CoS-Queue Mapping

#### CoS-Queue Mapping

CoS	0	1	2	3	4	5	6	7
Queue	0 ▼	0 ▼	0 ▼	1 ▼	2 ▼	2 ▼	3 ▼	3 ▼

Note: Queue 3 is the highest priority.

Apply

After configuring, click the **Apply** button to enable the settings.

## 4.6.3 DSCP-Queue Mapping

This is where users can change DSCP values to a Physical Queue mapping table. Since the switch fabric of the *JetNet 4006/4006f* supports 4 physical queues, (lowest, low, middle and high), users should assign a DSCP value to the level of the physical queue. With the

JetNet 4006/4006f users can easily change the mapping table to follow the upper layer 3 switch or routers' DSCP setting.

### Traffic Prioritization

#### DSCP-Queue Mapping

DSCP	0	1	2	3	4	5	6	7
Queue	1 ▼	1 ▼	1 ▼	1 ▼	1 ▼	1 ▼	1 ▼	1 ▼
DSCP	8	9	10	11	12	13	14	15
Queue	0 ▼	0 ▼	0 ▼	0 ▼	0 ▼	0 ▼	0 ▼	0 ▼
DSCP	16	17	18	19	20	21	22	23
Queue	0 ▼	0 ▼	0 ▼	0 ▼	0 ▼	0 ▼	0 ▼	0 ▼
DSCP	24	25	26	27	28	29	30	31
Queue	1 ▼	1 ▼	1 ▼	1 ▼	1 ▼	1 ▼	1 ▼	1 ▼
DSCP	32	33	34	35	36	37	38	39
Queue	2 ▼	2 ▼	2 ▼	2 ▼	2 ▼	2 ▼	2 ▼	2 ▼
DSCP	40	41	42	43	44	45	46	47
Queue	2 ▼	2 ▼	2 ▼	2 ▼	2 ▼	2 ▼	2 ▼	2 ▼
DSCP	48	49	50	51	52	53	54	55
Queue	3 ▼	3 ▼	3 ▼	3 ▼	3 ▼	3 ▼	3 ▼	3 ▼
DSCP	56	57	58	59	60	61	62	63
Queue	3 ▼	3 ▼	3 ▼	3 ▼	3 ▼	3 ▼	3 ▼	3 ▼

Note: Queue 3 is the highest priority queue.

Apply

After configuring, click the **Apply** button to enable the settings.

#### 4.6.4 CLI Commands for Traffic Prioritization

Command Lines for Traffic Prioritization configuration

Feature	Command Line
<b>QoS Setting</b>	
Queue Scheduling – Strict Priority	Switch(config)# qos queue-sched sp Strict Priority wrr Weighted Round Robin (Use an 8,4,2,1 weight) Switch(config)# qos queue-sched sp <cr>
Queue Scheduling - WRR	Switch (config)# qos queue-sched wrr
Port Setting – priority (Default Port Priority)	Switch(config)# interface <b>fa1</b> Switch(config-if)# qos priority DEFAULT-PRIORITY Assign an priority (3 highest) Switch(config-if)# qos cos 3 The default port priority value is set 3 ok.  <b>Note: When change the port setting, you should Select the specific port first. Ex: fa1 means fast Ethernet port 1.</b>
Port Setting – Trust Mode- CoS Only	Switch(config)# interface fa1 Switch(config-if)# qos trust cos The port trust is set CoS only ok.
Port Setting – Trust	Switch(config)# interface fa1

Mode- CoS Frist	Switch(config-if)# qos trust cos-first The port trust is set CoS first ok.
Port Setting – Trust Mode- DSCP Only	Switch(config)# interface fa1 Switch(config-if)# qos trust dscp The port trust is set DSCP only ok.
Port Setting – Trust Mode- DSCP First	Switch(config)# interface fa1 Switch(config-if)# qos trust dscp-first The port trust is set DSCP first ok.
Port Setting – Trust Mode- Port Based	Switch(config)# interface fa1 Switch(config-if)# qos trust port-based The port trust is set port based ok.
Display – Queue Scheduling	Switch# show qos queue-sched QoS queue scheduling scheme : Weighted Round Robin (Use an 8,4,2,1 weight)
Display – Port Setting - Trust Mode	Switch# show qos trust QoS Port Trust Mode : Port Trust Mode -----+----- 1 DSCP first 2 COS only 3 COS only 4 COS only 5 COS only 6 COS only 7 COS only 8 COS only 9 COS only 10 COS only
Display – Port Setting – CoS (Port Default Priority)	Switch# show qos port-cos Port Default Cos : Port CoS -----+----- 1 0 2 0 3 0 4 0 5 0 6 0
<b>CoS-Queue Mapping</b>	
Format	Switch(config)# qos cos-map PRIORITY Assign an priority (7 highest) Switch(config)# qos cos-map 1 QUEUE Assign an queue (0-3)  <b>Note: Format: qos cos-map priority_value queue_value</b>
Map CoS 0 to Queue 1	Switch(config)# qos cos-map 0 1 The CoS to queue mapping is set ok.
Map CoS 1 to Queue 0	Switch(config)# qos cos-map 1 0 The CoS to queue mapping is set ok.
Map CoS 2 to Queue 0	Switch(config)# qos cos-map 2 0 The CoS to queue mapping is set ok.
Map CoS 3 to Queue 1	Switch(config)# qos cos-map 3 1 The CoS to queue mapping is set ok.
Map CoS 4 to Queue 2	Switch(config)# qos cos-map 4 2

	The CoS to queue mapping is set ok.
Map CoS 5 to Queue 2	Switch(config)# qos cos-map 5 2 The CoS to queue mapping is set ok.
Map CoS 6 to Queue 3	Switch(config)# qos cos-map 6 3 The CoS to queue mapping is set ok.
Map CoS 7 to Queue 3	Switch(config)# qos cos-map 7 3 The CoS to queue mapping is set ok.
Display – CoS-Queue mapping	Switch# sh qos cos-map CoS to Queue Mapping : CoS Queue --- + ---- 0 1 1 0 2 0 3 1 4 2 5 2 6 3 7 3
<b>DSCP-Queue Mapping</b>	
Format	Switch(config)# qos dscp-map PRIORITY Assign an priority (63 highest) Switch(config)# qos dscp-map 0 QUEUE Assign an queue (0-3)  <b>Format: qos dscp-map priority_value queue_value</b>
Map DSCP 0 to Queue 1	Switch (config)# qos dscp-map 0 1 The TOS/DSCP to queue mapping is set ok.
Display – DSCO-Queue mapping	Switch# show qos dscp-map DSCP to Queue Mapping : (dscp = d1 d2)  d2  0 1 2 3 4 5 6 7 8 9 d1   -----+----- 0   1 1 1 1 1 1 1 1 0 0 1   0 0 0 0 0 0 0 0 0 0 2   0 0 0 0 1 1 1 1 1 1 3   1 1 2 2 2 2 2 2 2 2 4   2 2 2 2 2 2 2 2 3 3 5   3 3 3 3 3 3 3 3 3 3 6   3 3 3 3

## 4.7 Multicast Filtering

For multicast filtering, *JetNet 4006/4006f* uses IGMP Snooping technology. The IGMP (Internet Group Management Protocol) is an Internet Protocol that provides a way for an internet device to report its multicast group membership to adjacent routers. Multicasting allows one computer on the internet to send data to a multitude of other computers that have identified themselves as being interested in receiving the originating computers data.

Multicasting is useful for such applications as updating the address books of mobile computer users in the field, sending out newsletters to a distribution list, and broadcasting streaming media to an audience that has tuned into the event by setting up multicast group

membership.

In effect, IGMP Snooping manages multicast traffic by making use of switches, routers, and hosts that support IGMP. Enabling IGMP Snooping allows the ports to detect IGMP queries, report packets, and manage multicast traffic through the switch. IGMP has three fundamental types of messages, as shown below:

Message	Description
<b>Query</b>	A message sent from the querier (an IGMP router or a switch) which asks for a response from each host that belongs to the multicast group.
<b>Report</b>	A message sent by a host to the querier to indicate that the host wants to be or is a member of a given group indicated in the report message.
<b>Leave Group</b>	A message sent by a host to the querier to indicate that the host has quit as a member of a specific multicast group.

You can enable **IGMP Snooping** and **IGMP Query** functions here. You will see the information of the IGMP Snooping function in this section, including different multicast member ports and IP multicast addresses that range from 224.0.0.0 to 239.255.255.255.

The following commands are included in this group:

#### 4.8.1 IGMP Snooping

#### 4.8.2 IGMP Query

#### 4.8.3 CLI Commands of the Multicast Filtering

### 4.7.1 IGMP Snooping

This page is to enable/disable the IGMP Snooping feature and view the IGMP Snooping table from dynamic learnt.

**IGMP Snooping**, you can select **Enable** or **Disable** here.

**IGMP Snooping Table:** In the table, you can see the multicast group IP address and the member ports of the multicast group. The *JetNet 4006/4006f* supports 256 multicast groups. Click the **Reload** button to refresh the table.

**IGMP Snooping** Enable

Apply

**IGMP Snooping Table**

IP Address	VID	1	2	3	4	5	6
239.255.255.250	SVL	<input type="checkbox"/>	<input type="checkbox"/>	<input type="checkbox"/>	<input checked="" type="checkbox"/>	<input type="checkbox"/>	<input type="checkbox"/>

Reload

#### 4.7.2 IGMP Query

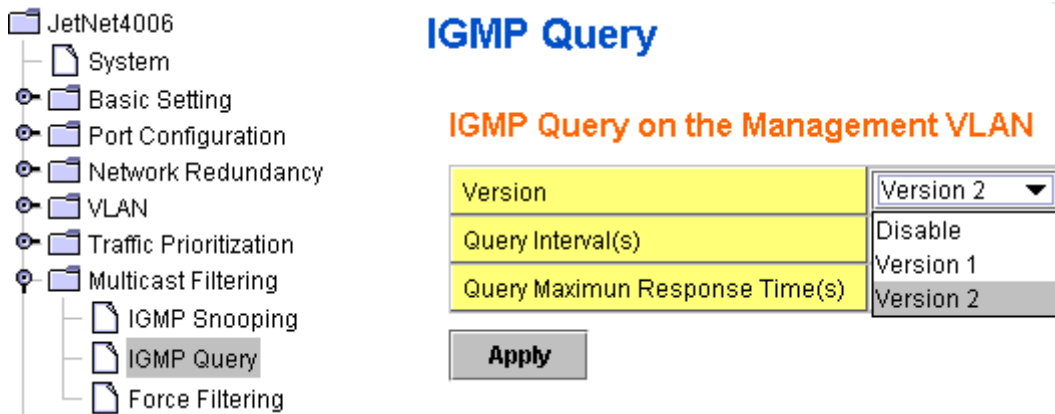

This page allows user to configure the **IGMP Query** feature. Since *JetNet 4006/4006f* can only be configured by the member ports of the management VLAN, so that the IGMP Query can only be enabled on the management VLAN. If you want to run IGMP Snooping feature in several VLANs, you should notice that whether each VLAN have their own IGMP Querier first.

The IGMP querier periodically sends query packets to all end-stations on the LANs or VLANs that are connected to it. For networks with more than one IGMP querier, a switch with the lowest IP address becomes the IGMP querier.

In the IGMP Query selection, you can select V1, V2 or Disable. **V1** means IGMP V1 General Query. The query will be forwarded to all multicast groups in the VLAN. **V2** means IGMP V2 Specific Query. The query will be forwarded to specific multicast groups. **Disable** allows you to disable the IGMP Query.

Once you finish configuring the settings, click the **Apply button** to apply your configuration.

#### 4.7.3 CLI Commands of the Multicast Filtering

The Command Lines of the multicast filtering configuration.

Feature	Command Line												
<b>IGMP Snooping</b>													
IGMP Snooping - Global	Switch(config)# ip igmp snooping IGMP snooping is enabled globally. Please specify on which vlans IGMP snooping enables												
Disable IGMP Snooping - Global	Switch(config)# no ip igmp snooping IGMP snooping is disabled globally ok.												
Display – IGMP Snooping Setting	Switch# sh ip igmp snooping IGMP snooping is globally enabled												
Display – IGMP Table	Switch# sh ip igmp snooping multicast all <table border="1" style="width: 100%; border-collapse: collapse;"> <thead> <tr> <th>VLAN</th> <th>IP Address</th> <th>Type</th> <th>Ports</th> </tr> </thead> <tbody> <tr> <td>SVL</td> <td>239.192.8.0</td> <td>IGMP</td> <td>fa6,</td> </tr> <tr> <td>SVL</td> <td>239.255.255.250</td> <td>IGMP</td> <td>fa6,</td> </tr> </tbody> </table>	VLAN	IP Address	Type	Ports	SVL	239.192.8.0	IGMP	fa6,	SVL	239.255.255.250	IGMP	fa6,
VLAN	IP Address	Type	Ports										
SVL	239.192.8.0	IGMP	fa6,										
SVL	239.255.255.250	IGMP	fa6,										
<b>IGMP Query</b>													

IGMP Query V1	Switch(config)# int vlan 1 (Go to management VLAN) Switch(config-if)# ip igmp v1
IGMP Query V2	Switch(config)# int vlan 1 (Go to management VLAN) Switch(config-if)# ip igmp
IGMP Query version	Switch(config-if)# ip igmp version 1 Switch(config-if)# ip igmp version 2
IGMP Query Interval	Switch(config)# int vlan 1 (Go to management VLAN) Switch(config-if)# ip igmp Switch(config-if)# ip igmp query-interval 60 (Change query interval to 60 seconds, default value is 125 seconds)
IGMP Query Max Response Time	Switch(config)# int vlan 1 (Go to management VLAN) Switch(config-if)# ip igmp Switch(config-if)# ip igmp query-max-response-time 15 (Change query max response time to 15 seconds, default value is 10 seconds)
Disable	Switch(config)# int vlan 1 Switch(config-if)# no ip igmp
Display	Switch# sh ip igmp interface vlan1 enabled: Yes version: IGMPv2 query-interval: 125s query-max-response-time: 10s  Switch# show running-config .... ! interface vlan1 ip address 192.168.10.17/24 ip igmp no shutdown ! .....



## 4.8 SNMP

Simple Network Management Protocol (SNMP) is a protocol used for exchanging management information between network devices. SNMP is a member of the TCP/IP protocol suite. *JetNet 4006/4006f* supports SNMP v1, v2c and v3.

A SNMP managed network consists of two main components: agents and a manager. An agent is a management software module that resides in a managed switch. An agent translates the local management information from the managed device into a SNMP-compatible format. The manager is the console through the network.

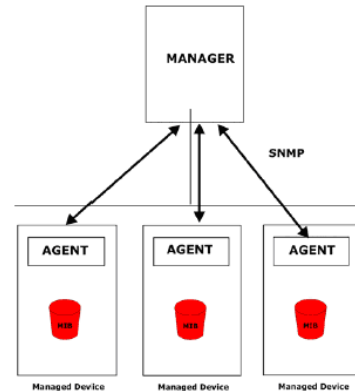

The following commands are included in this section:

- 4.9.1 SNMP Configuration
- 4.9.2 SNMP v3 Profile
- 4.9.2 SNMP Traps
- 4.9.3 CLI Commands for SNMP

### 4.8.1 SNMP Configuration

This allows users to configure the SNMP V1/ V2c Community. The community string can be viewed as a password because SNMP V1/ V2c doesn't request you to enter a password before accessing the SNMP agent.

The community includes 2 privileges: Read Only, and Read and Write.

With **Read Only** privileges, you will only have the ability to read the values in the MIB tables. The default community string is set to Public.

With **Read and Write** privileges, you will have the ability to read and set the values in the MIB tables. The default community string is set to Private.

## SNMP

### SNMP V1/V2c Community

Community String	Privilege
public	Read Only ▼
private	Read and Write ▼
	Read Only ▼
	Read Only ▼

**Apply**

*JetNet 4006/4006f* allows users to assign 4 community strings. Type in each community string and select its privilege. Then press the **Apply button**.

**Note:** When you first install the device onto your network, we highly recommend that you change the community string. Because most SNMP management applications use Public and Private as their default community name, this may cause a leak in network security.

#### 4.8.2 SNMP v3 Profile

SNMP v3 can provide more security functions when the user performs remote management through SNMP protocol. It delivers SNMP information to the administrator with user authentication; all of data between *JetNet 4006/4006f* and the administrator are encrypted to ensure secure communication.

### SNMP V3 Profile

#### SNMP V3

User Name	<input type="text"/>
Security Level	Authentication ▼
Authentication Portocol	SHA ▼
Authentication Password	<input type="text"/>
DES Encryption Password	<input type="text"/>

**Security Level:** Here the user can select the following levels of security: None, User Authentication, and Authentication with privacy.

**Authentication Protocol:** Here the user can select either MD5 (Message-Digest algorithm 5) or SHA (Secure Hash Algorithm). MD5 is a widely used cryptographic hash function with a 128-bit hash value. SHA (Secure Hash Algorithm) hash functions refer to five Federal Information Processing Standard-approved algorithms for computing a condensed digital representation. *JetNet 4006/4006f* provides 2 user authentication protocols in MD5 and SHA. You will need to configure SNMP v3 parameters for your SNMP tool with the same authentication method.

**Authentication Password:** Here the user enters the SNMP v3 user authentication password.

**DES Encryption Password:** Here the user enters the password for SNMP v3 user DES Encryption.

### 4.8.3 SNMP Traps

SNMP Trap is a notification feature defined by SNMP protocol. All SNMP management applications can understand this type of trap information. You will not need to install new applications to read the notification information.

This page allows users to **Enable SNMP Trap**, configure the **SNMP Trap server IP**, **Community** name, and trap **Version V1 or V2**. After the configuration, you will be able to see the changes made to the SNMP pre-defined standard traps and the *Korenix* pre-defined traps. The pre-defined traps can be found in *Korenix*'s private MIB.

## SNMP Trap

**SNMP Trap**

**Apply**

### SNMP Trap Server

Server IP	<input type="text"/>
Community	<input type="text"/>
Version	<input checked="" type="radio"/> V1 <input type="radio"/> V2c

**Add**

### Trap Server Profile

Server IP	Community	Version
192.168.10.200	public	V2c
192.168.10.200	public	V1
<input type="text"/>		

**Remove**

**Reload**

#### 4.8.4 CLI Commands for SNMP

Command Lines for SNMP configuration

Feature	Command Line
<b>SNMP Community</b>	
Read Only Community	Switch(config)# snmp-server community public ro community string add ok
Read Write Community	Switch(config)# snmp-server community private rw community string add ok
<b>SNMP Trap</b>	
Enable Trap	Switch(config)# snmp-server enable trap Set SNMP trap enable ok.
SNMP Trap Server IP without specific community name	Switch(config)# snmp-server host 192.168.10.33 SNMP trap host add OK.
SNMP Trap Server IP with version 1 and community	Switch(config)# snmp-server host 192.168.10.33 version 1 private SNMP trap host add OK. <b>Note: private is the community name, version 1 is the SNMP version</b>
SNMP Trap Server IP with version 2 and community	Switch(config)# snmp-server host 192.168.10.33 version 2 private SNMP trap host add OK.
Disable SNMP Trap	Switch(config)# no snmp-server enable trap Set SNMP trap disable ok.
Display	Switch# sh snmp-server trap SNMP trap: Enabled SNMP trap community: public  Switch# show running-config ..... snmp-server community public ro snmp-server community private rw snmp-server enable trap snmp-server host 192.168.10.33 version 2 admin snmp-server host 192.168.10.33 version 1 admin .....

## 4.9 Security

In the IP Security section, you will be able to set up specific IP addresses to perform authorization for management access to *JetNet 4006/4006f* via web browser, Telnet or SNMP.

### IP Security

IP Security

Once you have finished configuring the settings, click the **Apply/Add** button to apply your configuration.

#### 4.9.1 IP Security

**Add Security IP:** You can assign any PC as an administrator workstation by adding a PC's IP address into the Security IP field. Only these IP addresses will be able to access and manage *JetNet 4006/4006f*. The maximum number of security IP is 10.

**Security IP List:** This table shows you each security IP address you have added. You can hit **Remove** to delete, and **Reload** to reload the table.

#### Add Security IP

Security IP

#### Security IP List

Index	Security IP
1	192.168.10.200

Once you have finished configuring the settings, click the **Apply** button to apply your configuration.

#### 4.9.2 CLI Commands for Security

Command Lines for Security configuration

Feature	Command Line
<b>IP Security</b>	
IP Security	Switch(config)# ip security Set ip security enable ok. Switch(config)# ip security host 192.168.10.33 Add ip security host 192.168.10.33 ok.
Display	Switch# show ip security ip security is enabled ip security host: 192.168.10.33

### 4.10 Warning

*JetNet 4006/4006f* provides several types of warning features for remote monitoring and even provides a real-time alert mechanism. These features include a System Log for local and remote servers, SMTP E-mail alerts and a Fault Relay alarm.

The following commands are included in this section:

- 4.11.1 Fault Relay Setting
- 4.11.2 Event Selection
- 4.11.3 Syslog Configuration
- 4.11.4 SMTP Configuration
- 4.11.5 CLI Commands for Warning

#### 4.10.1 Fault Relay Setting

*JetNet 4006/4006f* provides 1 digital output, also known as Relay Output. The relay contacts are energized (open) for normal operation and will close under faulty conditions. Faulty conditions include Power Failure, Ethernet port Link Failure, Ping Failure and Super Ring Topology Change. You can enable and select relay trigger by clicking the **Apply** button.

**Relay 1:** Check the box **Relay 1**, then select the Event Type and its parameters.

## Fault Relay Setting

<input checked="" type="checkbox"/> Relay 1	
Event Type	Ping Failure
IP Address	Dry Output
Reset Time(Sec)	Power Failure
Hold Time(Sec)	Link Failure
	Ping Failure
	Super Ring Failure
<b>Apply</b>	

**Event Type:** You will be given the following options: Dry Output, Power Failure, Link Failure, Ping Failure and Super Ring Failure. Each event type has its own parameters and are configurable. Each Relay can have one event type.

<input checked="" type="checkbox"/> Relay 1	
Event Type	Dry Output
On Period(Sec)	5
Off Period(Sec)	10

**Event Type:** Dry Output

**On Period (Sec):** Type in the amount of time you would like Relay Output to be on. This can range from 0-4294967295 seconds.

**Off Period (Sec):** Type in the amount of time you would like Relay Output to be off. This can range from 0-4294967295 seconds.

When the amount of time is reached, the system will turn the Relay Output on or off.

<input checked="" type="checkbox"/> Relay 1	
Event Type	Power Failure
Power ID	Power 1

**Event Type:** Power Failure

**Power ID:** Select either Power 1 or Power 2. When power is shut down, the system will short Relay Out and light the DO LED.

## Fault Relay Setting

<input checked="" type="checkbox"/> Relay 1						
Event Type	Link Failure					
Link	1	2	3	4	5	6
	<input checked="" type="checkbox"/>	<input type="checkbox"/>	<input checked="" type="checkbox"/>	<input type="checkbox"/>	<input type="checkbox"/>	<input type="checkbox"/>

**Apply**

**Event Type:** Link Failure

**Link:** Select the port ID you would like to monitor.

How to configure: Check the box of the Ethernet ports you wish to monitor. You may select multiple ports. When the selected ports are unlinked, the system will short Relay Output and light the DO LED.

<input checked="" type="checkbox"/> Relay 1	
Event Type	Ping Failure
IP Address	192.168.10.100
Reset Time(Sec)	10
Hold Time(Sec)	40

**Event Type:** Ping Failure

**IP Address:** Enter the IP address of the target device you want to ping.

**Reset Time (Sec):** Enter the amount of time after ping has failed that you would like the relay output to turn off

**Hold Time (Sec):** Enter the amount of time after ping has failed and relay output has been turned off, that you would like the relay output to be turned back on.

How to configure: After selecting the Ping Failure event type, the system will change the Relay Output to “short” state, light the alarm LED and continuously ping the target device. When the ping failure for Reset Time times out, the system will change the Relay Output to “open” state and turn off the alarm LED for the amount of time entered in **Hold Time**. After the Hold Time times out, the system will start sending ping commands to the remote device.

Ex: When the **Reset Time** is set to 10 sec while the **Hold Time** is set to 40 sec the following will occur: After ping has failed after 10 seconds (Reset Time), the system will turn the Relay Output and Alarm LED off. After 40 seconds (Hold Time), the system will turn the Relay Output and alarm LED on again.



The change of state of a Relay Output Ping Failure Event, see the chart below.

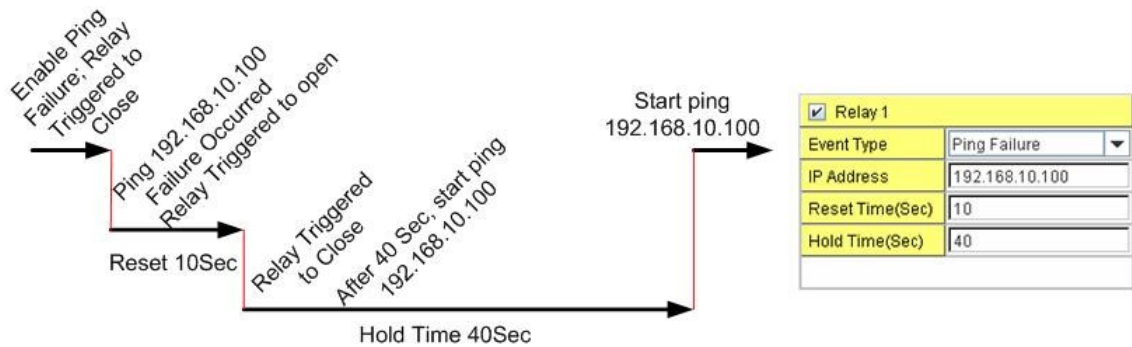

Select Super Ring Failure. When the Rapid Super Ring topology is changed, the system will short Relay Out and light the alarm LED.

<input checked="" type="checkbox"/> Relay 1	
Event Type	Super Ring Failure

Once you have finished configuring the settings, click the **Apply** button to apply your configuration.

#### 4.10.2 Event Selection

Event Types are divided into 3 basic groups: System Events, Port Events and PoE Events. System Events relate to the overall function of the switch whereas Port Events relate to the activity of specific ports.

System Event	Warning Event is sent when.....
Device Cold Start	Power is cut off and then reconnected.
Device Warm Start	Reboot the device by CLI or Web UI.
Power 1 Failure	Power 1 is failure.
Power 2 Failure	Power 2 is failure.
Authentication failure	An incorrect password, SNMP Community String is entered.
Time Synchronize Failure	Time Synchronize Failure
Fault Relay	The DO/Fault Relay is on.

Super Ring Topology Changes	Master of Super Ring has changed or backup path is activated.
<b>Port Event</b>	<b>Warning Event is sent when.....</b>
Link-Up	The port is connected to another device
Link-Down	The port is disconnected (e.g. the cable is pulled out, or the opposing devices turns down)

## Warning - Event Selection

### System Event Selection

- |  |  |
|--|--|
| <input checked="" type="checkbox"/> Device Cold Start      | <input checked="" type="checkbox"/> Device Warm Start          |
| <input checked="" type="checkbox"/> Power 1 Failure        | <input checked="" type="checkbox"/> Power 2 Failure            |
| <input checked="" type="checkbox"/> Authentication Failure | <input checked="" type="checkbox"/> Time Synchronize Failure   |
| <input checked="" type="checkbox"/> Fault Relay            | <input checked="" type="checkbox"/> Super Ring Topology Change |

### Port Event Selection

### PoE Event Selection

Port	Link State
1	Link Up ▼
2	Link Down ▼
3	Disable ▼
4	Disable ▼
5	Disable ▼
6	Disable ▼

Port	PoE Powering Event
1	Enable ▼
2	Enable ▼
3	Enable ▼
4	Enable ▼

**Apply**

Once you have finished configuring the settings, click the **Apply** button to apply your configuration.

### 4.10.3 SysLog Configuration

System Log is useful in providing the system administrator both local and remote monitoring of the switch's history. There are 2 System Log modes provided by JetNet 4006/4006f: local mode and remote mode.

**Local Mode:** In this mode, *JetNet 4006/4006f* will print selected past events (selected in the Event Selection page) to the System Log table of *JetNet 4006/4006f*. You can monitor the system logs in the [Monitor and Diag] / [Event Log] page.

**Remote Mode:** The remote mode is also known as Server mode in the *JetNet 4706* series. In this mode, you should assign the IP address of the System Log server. *JetNet 4006/4006f* will send the selected occurrences, selected on the Event Selection page, to the System Log server that you have assigned.

**Both:** The 2 modes mentioned above can be enabled at the same time.

### Warning - SysLog Configuration

Syslog Mode	Disable
Remote IP Address	Disable
	Local
	Remote
	Both

Note: When enabled Local or Remote for the system logs in the [Monitor and Diag] / [Event Log] page.

**Apply**

Once you have finished configuring the settings, click the **Apply** button to apply your configuration.

**Note:** When enabling Local or Both modes, you can monitor the system logs in [Monitor and Diag] / [Event Log] page.

#### 4.10.4 SMTP Configuration

The *JetNet 4006/4006f* includes an E-mail Warning feature. The switch will send occurrences to a remote E-mail server. The receiver can then receive an E-mail notification by E-mail to SMTP standards.

This section, shown in the next image, allows you to enable the E-mail Alert, and assign the SMTP Server IP, Sender E-mail, and Receiver E-mail. If the SMTP server requests your authorization first, here you can also set up the username and password for that.

### Warning - SMTP Configuration

**E-mail Alert**      Disable

**SMTP Configuration**

SMTP Server IP	192.168.10.1
Mail Account	admin@korenix.com
<input type="checkbox"/> Authentication	
User Name	
Password	
Confirm Password	
Rcpt E-mail Address 1	
Rcpt E-mail Address 2	
Rcpt E-mail Address 3	
Rcpt E-mail Address 4	

**Apply**

Field	Description
SMTP Server IP Address	Enter the IP address of the email Server
Authentication	Click the check box to enable password
User Name	Enter email Account name (Max.40 characters)
Password	Enter the password of the email account
Confirm Password	Re-type the password of the email account
You can set up to 4 email addresses to receive email alarm from JetNet	
Rcpt E-mail Address 1	The first email address to receive email alert from JetNet (Max. 40 characters)
Rcpt E-mail Address 2	The second email address to receive email alert from JetNet (Max. 40 characters)
Rcpt E-mail Address 3	The third email address to receive email alert from JetNet (Max. 40 characters)
Rcpt E-mail Address 4	The fourth email address to receive email alert from JetNet (Max. 40 characters)

Once you have finished configuring the settings, click the **Apply** button to apply your configuration.

#### 4.10.5 CLI Commands for Warning

Command Lines for Warning configuration

Feature	Command Line
<b>Relay Output</b>	
Relay Output	Switch(config)# relay 1 dry dry output ping ping failure port port link failure power power failure ring super ring failure
Dry Output	Switch(config)# relay 1 dry <0-4294967295> turn on period in second Switch(config)# relay 1 dry 5 <0-4294967295> turn off period in second Switch(config)# relay 1 dry 5 5
Ping Failure	Switch(config)# relay 1 ping 192.168.10.33 <cr> reset reset a device Switch(config)# relay 1 ping 192.168.10.33 reset <1-65535> reset time Switch(config)# relay 1 ping 192.168.10.33 reset 60 <0-65535> hold time to retry

	Switch(config)# relay 1 ping 192.168.10.33 reset 60 60
Port Link Failure	Switch(config)# relay 1 port PORTLIST port list Switch(config)# relay 1 port fa1-5
Power Failure	Switch(config)# relay 1 power <1-2> power id Switch(config)# relay 1 power 1 Switch(config)# relay 1 power 2
Super Ring Failure	Switch(config)# relay 1 ring
Disable Relay	Switch(config)# no relay <1-2> relay id Switch(config)# no relay 1 (Relay_ID: 1 or 2) <cr>
Display	Switch# show relay 1 Relay Output Type : Port Link Port : 1, 2, 3, 4, Switch# show relay 2 Relay Output Type : Super Ring
<b>Event Selection</b>	
Event Selection	Switch(config)# warning-event coldstart Switch cold start event warmstart Switch warm start event linkdown Switch link down event linkup Switch link up event all Switch all event authentication Authentication failure event fault-relay Switch fault relay event power Switch power failure event super-ring Switch super ring topology change event time-sync Switch time synchronize failure event
Ex: Cold Start event	Switch(config)# warning-event coldstart Set cold start event enable ok.
Ex: Link Up event	Switch(config)# warning-event linkup [IFNAME] Interface name, ex: fastethernet1 or gi8 Switch(config)# warning-event linkup fa5 Set fa5 link up event enable ok.
Display	Switch# show warning-event Warning Event: Cold Start: Enabled Warm Start: Disabled Authentication Failure: Disabled Link Down: fa4-5 Link Up: fa4-5 Power Failure: Super Ring Topology Change: Disabled Fault Relay: Disabled
<b>Syslog Configuration</b>	
Local Mode	Switch(config)# log syslog local
Server Mode	Switch(config)# log syslog remote 192.168.10.33
Both	Switch(config)# log syslog local Switch(config)# log syslog remote 192.168.10.33
Disable	Switch(config)# no log syslog local
<b>SMTP Configuration</b>	
SMTP Enable	Switch(config)# smtp-server enable email-alert

	SMTP Email Alert set enable ok.
Sender mail	Switch(config)# smtp-server server 192.168.10.100 ACCOUNT SMTP server mail account, ex: admin@korenix.com Switch(config)# smtp-server server 192.168.10.100 admin@korenix.com SMTP Email Alert set Server: 192.168.10.100, Account: admin@korenix.com ok.
Receiver mail	Switch(config)# smtp-server receipt 1 korecare@korenix.com SMTP Email Alert set receipt 1: korecare@korenix.com ok.
Authentication with username and password	Switch(config)# smtp-server authentication username admin password admin SMTP Email Alert set authentication Username: admin, Password: admin  Note: You can assign string to username and password.
Disable SMTP	Switch(config)# no smtp-server enable email-alert SMTP Email Alert set disable ok.
Disable Authentication	Switch(config)# no smtp-server authentication SMTP Email Alert set Authentication disable ok.
Display	Switch# sh smtp-server SMTP Email Alert is Enabled Server: 192.168.10.100, Account: admin@korenix.com Authentication: Enabled Username: admin, Password: admin SMTP Email Alert Receipt: Receipt 1: korecare@korenix.com Receipt 2: Receipt 3: Receipt 4:

## 4.11 Monitoring and Diagnostic

*JetNet 4006/4006f* provides several types of features for you to monitor the status of the switch or create a diagnostic for you to check the problem when issues with the switch occur. Features include MAC Address Table, Port Statistics, Event Log and Ping.

The following commands are included in this section:

4.12.1 MAC Address Table

4.12.2 Port Statistics

4.12.3 Event Log

4.12.4 Ping

4.12.5 CLI Commands for Monitoring and Diagnostic

### 4.11.1 MAC Address Table

*JetNet 4006/4006f* provides 2K of entries in the MAC Address Table. On this page, users can change the Aging time, add Static Unicast MAC Address, monitor the MAC address or sort them by different packet types and ports. Click the **Apply** button to change the value.

#### Aging Time (Sec)

Each switch fabric has a limited amount of space to write the learnt MAC address. To save more entries for new MAC address, the switch fabric will age out any unused MAC address entries with respect to the Aging Time. The default Aging Time is 300 seconds. The Aging Time can be modified on this page.

#### Static Unicast MAC Address

For some applications, users may need to type the static Unicast MAC address into its MAC address table. On this page, you can type in the MAC Address (format: xxxx.xxxx.xxxx), and select its VID and Port ID. Click the **Add** button to add it to the MAC Address table.

#### MAC Address Table

In the MAC Address Table, you can see all the MAC Addresses learned by the switch fabric. The packet types include Management Unicast, Static Unicast, Dynamic Unicast, Static Multicast and Dynamic Multicast. The table allows users to sort the addresses by the packet types and the port.

**Packet Types: Management Unicast** refers to the MAC address of the switch. It belongs to the CPU port only. The **Static Unicast** MAC address can be added and deleted. **Dynamic Unicast** MAC is the MAC address learned by the switch Fabric. **Static Multicast** can be added through CLI and can be deleted through the Web and CLI. **Dynamic Multicast** will appear after you have enabled IGMP and after the switch learns the IGMP report.

Click the **Remove** button to remove the Static Unicast/Multicast MAC address. Click the **Reload** button to refresh the table. Newly learned Unicast/Multicast MAC addresses will be updated to the MAC address table.

## MAC Address Table

Aging Time (Sec)

**Apply**

### Static Unicast MAC Address

MAC Address	VID	Port
<input type="text"/>	<input type="text"/>	Port 1 ▾

**Add**

MAC Address Table

MAC Address	Address Type	VID	1	2	3	4	5	6
000f.b079.cb93	Dynamic Unicast	SVL	<input checked="" type="checkbox"/>	<input type="checkbox"/>	<input type="checkbox"/>	<input type="checkbox"/>	<input type="checkbox"/>	<input type="checkbox"/>

**Remove**

**Reload**

### 4.11.2 Port Statistics

On this page, you can view operational statistics for each port. The statistics that can be viewed include Link Type, Link State, Rx Good, Rx Bad, Tx Good, and Collision. Rx means the received packets while Tx means the transmitted packets. The statistics can just show Rx Good and Tx Good or Rx Bad and Collision.

*Note: If you see an increase in Bad or Collision counts, this may mean that your network cable is not connected correctly or the network performance of the port is poor. Please check your network cable, Network Interface Card connected to your device, the network application, or reallocate the network traffic.*

Click the **Clear Selected** button to reset the counts of the selected ports and the **Clear All** button to reset the counts of all ports. Click the **Reload** button to refresh the counts. Also, Click the **Bad-Collision Mode** button to change counter mode to RxBad and TxCollisions mode and the **Good Mode** button to change counter mode to RxGood and TxGood mode.

*Note: If the mode is changed. The statistics counter will be reset to 0..*



## Port Statistics

Port	Type	Link	State	Rx Good	Rx Bad	Tx Good	Collision
1	100BASE	Down	Enable	0	--	0	--
2	100BASE	Down	Enable	0	--	0	--
3	100BASE	Down	Enable	0	--	0	--
4	100BASE	Down	Enable	0	--	0	--
5	100BASE	Down	Enable	0	--	0	--
6	100BASE-TX	Up	Enable	212	--	230	--

### 4.11.3 Event Log

In section 4.10.3, we introduced the System Log feature. When System Log Local mode is selected, *JetNet 4006/4006f* will record past events in the local log table. This page shows the log table. The entries include the index, and data, time and content of the occurrences.

Click the **Clear** button to delete the entries. Click the **Reload** button to refresh the table.

## System Event Logs

Index	Date	Time	Event Log
1	Jan 1	05:00:16	Event: Link 1 Up.
2	Jan 1	05:00:11	Event: Link 1 Up.
3	Jan 1	05:00:11	Event: Link 1 Down.
4	Jan 1	05:00:09	Event: Link 2 Up.
5	Jan 1	05:00:09	Event: Link 2 Down.
6	Jan 1	05:00:07	Event: Link 1 Down.

### 4.11.4 Ping Utility

This page provides **Ping Utility** for users to ping remote devices and to check whether the device is alive or not. Type the target IP address of the target device into **Target IP**. Click the **Start** button to start the ping. You will be able to see the results in the **Result** field.

## Ping Utility

### Ping

Target IP

### Result

```

PING 192.168.10.200 (192.168.10.200): 56 data bytes
64 bytes from 192.168.10.200: icmp_seq=0 ttl=128 time=0.0 ms
64 bytes from 192.168.10.200: icmp_seq=1 ttl=128 time=0.0 ms
64 bytes from 192.168.10.200: icmp_seq=2 ttl=128 time=0.0 ms
64 bytes from 192.168.10.200: icmp_seq=3 ttl=128 time=0.0 ms
64 bytes from 192.168.10.200: icmp_seq=4 ttl=128 time=0.0 ms

--- 192.168.10.200 ping statistics ---
5 packets transmitted, 5 packets received, 0% packet loss
round-trip min/avg/max = 0.0/0.0/0.0 ms
    
```

#### 4.11.5 CLI Commands for Monitoring and Diagnostic

Command Lines for Monitoring and Diagnostic configuration

Feature	Command Line
<b>MAC Address Table</b>	
Ageing Time	Switch(config)# mac-address-table aging-time 350 mac-address-table aging-time set ok!  <i>Note: 350 is the new ageing timeout value.</i>
Add Static Unicast MAC address	Switch(config)# mac-address-table static 0012.7701.0101 vlan 1 interface fastethernet1 mac-address-table ucast static set ok!  <b>Note: rule: mac-address-table static MAC_address VLAN VID interface interface_name</b>
Add Multicast MAC address	Switch(config)# mac-address-table multicast 0100.5e01.0101 vlan 1 interface fa1-6 Adds an entry in the multicast table ok!  <b>Note: rule: mac-address-table multicast MAC_address VLAN VID interface_list interface_name/range</b>
Show MAC Address Table – All types	Switch# show mac-address-table  ***** UNICAST MAC ADDRESS ***** Destination Address    Address Type    Vlan    Destination Port ----- 000f.b079.ca3b        Dynamic        1        fa1 0012.7701.0386        Dynamic        1        fa2 0012.7710.0101        Static        1        fa6 0012.7710.0102        Static        1        fa6 0012.77ff.0100        Management    1  ***** MULTICAST MAC ADDRESS *****

	<pre> Vlan  Mac Address      COS   Status  Ports ----  - 1     0100.5e40.0800      0    fa6 1     0100.5e7f.ffa      0    fa4,fa6           </pre>
Show MAC Address Table – Dynamic Learnt MAC addresses	<pre> Switch# show mac-address-table dy Destination Address  Address Type  Vlan  Destination Port ----- 000f.b079.cb93      Dynamic      SVL   fa1           </pre>
Show MAC Address Table – Multicast MAC addresses	<pre> Switch# show mac-address-table multicast JetNet 4006 Mana# show mac-address-table multicast Vlan  Mac Address      COS   Status  Ports ----  -           </pre>
Show MAC Address Table – Static MAC addresses	<pre> Switch# show mac-address-table static Destination Address  Address Type  Vlan  Destination Port ----- 0012.7710.0101      Static        1     fa6 0012.7710.0102      Static        1     fa6           </pre>
Show Aging timeout time	<pre> Switch# show mac-address-table aging-time the mac-address-table aging-time is 304 sec.           </pre>

<b>Port Statistics</b>	
Port Statistics	<pre> Switch# show rmon statistics fa4 (select interface) RMON statistics counter mode is RxGood and TxGood mode. Interface fastethernet1 is enable connected, which has   Inbound:     RxGood: 1292   Outbound:     TxGood: 1978           </pre>
Bad-Collision Mode	<pre> Switch(config)# rmon statistics counter-mode error-collisions Set RMON statistics counter mode to RxError and TxCollisions mode.           </pre>
Good Mode	<pre> Switch(config)# rmon statistics counter-mode good Set RMON statistics counter mode to RxGood and TxGood mode.           </pre>
<b>Event Log</b>	
Display	<pre> Switch# show event-log &lt;1&gt;Jan  1 02:50:47 snmpd[101]: Event: Link 4 Down. &lt;2&gt;Jan  1 02:50:50 snmpd[101]: Event: Link 5 Up. &lt;3&gt;Jan  1 02:50:51 snmpd[101]: Event: Link 5 Down. &lt;4&gt;Jan  1 02:50:53 snmpd[101]: Event: Link 4 Up.           </pre>
<b>Ping</b>	
Ping IP	<pre> Switch# ping 192.168.10.33 PING 192.168.10.33 (192.168.10.33): 56 data bytes 64 bytes from 192.168.10.33: icmp_seq=0 ttl=128 time=0.0 ms 64 bytes from 192.168.10.33: icmp_seq=1 ttl=128 time=0.0 ms 64 bytes from 192.168.10.33: icmp_seq=2 ttl=128 time=0.0 ms 64 bytes from 192.168.10.33: icmp_seq=3 ttl=128 time=0.0 ms 64 bytes from 192.168.10.33: icmp_seq=4 ttl=128 time=0.0 ms  --- 192.168.10.33 ping statistics --- 5 packets transmitted, 5 packets received, 0% packet loss round-trip min/avg/max = 0.0/0.0/0.0 ms           </pre>

## 4.12 Device Front Panel

**Device Front Panel** provides Web type LED panel which indicates status of power, PoE powering and link status of Ethernet.

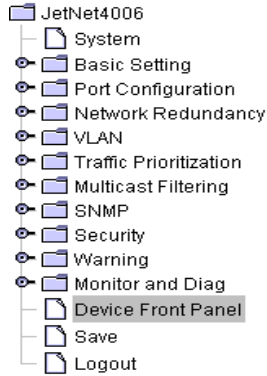

### Device Front Panel



## 4.13 Save to Flash

**Save Configuration** allows you to save any configuration you just made to the Flash. Powering off the switch without clicking **Save Configuration** will cause loss of new settings. After selecting **Save Configuration**, click the “**Save to Flash**” button to save your new configuration.

### Save to Flash

Note: This command will permanently save the current configuration to flash.



#### Command Lines:

Feature	Command Line
Save	Switch# write Building Configuration... [OK]  Switch# copy running-config startup-config Building Configuration... [OK]

## 4.14 Logout

The switch provides 2 logout methods. Your web connection will log out if you do not input a command for 30 seconds. The Logout command allows you to manually log out the web connection. Click **Yes** to logout, and **No** to go back to the configuration page.

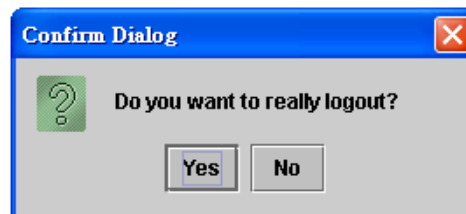
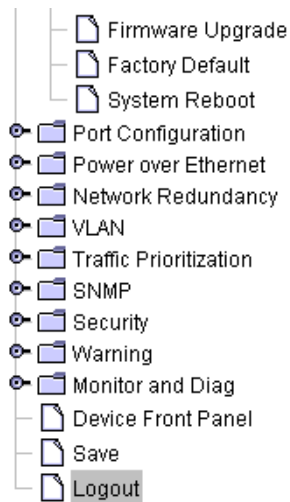

### Command Lines:

Feature	Command Line
Logout	Switch> exit
	Switch# exit

# 5 Appendix

## 5.1 Product Specifications

<b>Technology</b>	
<b>Standard</b>	IEEE 802.3 10Base-T IEEE 802.3u 100Base-TX IEEE 802.1p Class of Service IEEE 802.1d Spanning Tree. IEEE 802.1w Rapid Spanning Tree
<b>Performance</b>	
<b>Switch Technology</b>	Store and Forward Technology with 3.2Gbps wire-speed non-blocking Switch Fabric
<b>System Throughput</b>	1.785Mpps
<b>MAC Address</b>	2000
<b>Packet Buffer</b>	Embedded 1Mbits shared buffer
<b>Transfer performance</b>	14,880pps for Ethernet and 148,800 for Fast Ethernet and transfer packet size from 64 to 1522Bytes
<b>Management interface</b>	SNMP v1, v2c and v3, Web browser and Console Management
<b>SNMP MIB</b>	RFC 1213 MIBII, RFC 1493 Bridge MIB, RFC 1757 RMON MIB, RFC 2674 VLAN MIB, RFC 1643 Ethernet like MIB, RFC1215 Trap MIB, , Korenix Private MIB
<b>SNMP Trap</b>	The SNMP trap agent provides Cold start, Warm start, Port event, Power event, Authentication failure
<b>System Log</b>	1000 system entries for system or remote log server
<b>Class of Service</b>	IEEE 802.1p class of service, with 4 priority queues per port
<b>Quality of Service</b>	Quality of Service determined by port, Tag and IPv4 Type of Service
<b>DHCP</b>	DHCP Client, DHCP Server and DHCP Relay (DHCP option 82) The DHCP-Server functions supports specified IP exclude and MAC binding function.
<b>Timer</b>	Support Network Time Protocol (NTP) to synchronize time from internet
<b>VLAN</b>	Port Based VLAN with Tagged, Un-Tagged and not modified function
<b>IGMP</b>	The IGMP supports IGMP v1, V2C protocol with IGMP Snooping and Query functions
<b>Network Redundancy</b>	Supports Rapid Super Ring function for network redundancy with 30ms network recovery time; To inter-operate with other higher-level switches, it provides Rapid Dual Homing (R.D.H.) technology compliant with RSTP protocol JetNet 4006 is also compliant with IEEE802.1d 2004 edition for RSTP and STP
<b>IEEE 802.1AB LLDP</b>	Supports Link Layer Discovery Protocol for device discovery and for building network infrastructure map
<b>Event Alarm Relay</b>	1 Dry Relay Contact output for port link down and System power events Supports 1A @24V current ability



<b>Firmware upgrade</b>	TFTP and HTTP firmware upgrade
<b>Interface</b>	
<b>Number of Ports</b>	6 x 10/100 Base-TX 1 x RS-232 Console
<b>Connectors</b>	10/100TX: RJ-45 RS-232 Console: RJ-45 6-pin Terminal Block: Power 1 and 2, Dry Relay Alarm Output
<b>Cable</b>	10Base-T: 4-pair UTP/STP Cat. 3, 4, 5 cable, EIA/TIA-568B 100-ohm(100m) 100Base-TX: 4-pair UTP/STP Cat.5, Cat.5E/Cat.6 cable, EIA/TIA-568B 100-ohm(100m)
<b>Rest Button</b>	For system reboot and factory default setting
<b>Diagnostic LED</b>	Power LED: Power 1/Power 2 (Green) Fast Ethernet Port 1~6: Link (Green) /Activity (Green blinking) Alarm (Red): Port link down or power failure occurred – software configuration
<b>Power Requirements</b>	
<b>System Power</b>	Redundant Power input with polarity reverse function Power Input: DC 12~48V
<b>Power Consumption</b>	8 Watts @ 48V (Maximum)
<b>Mechanical</b>	
<b>Installation</b>	DIN-Rail mount or desktop
<b>Case</b>	IP-31 grade aluminum metal case
<b>Dimension</b>	45.5 mm (H) x 185.3 mm (W) x 136 mm (D) without DIN
<b>Weight</b>	0.62 kg with package 0.55 kg without package
<b>Environmental</b>	
<b>Operating Temperature</b>	-25°C ~70°C
<b>Operating Humidity</b>	5% ~ 90% non-condensing
<b>Storage Temperature</b>	-40°C ~ 80 °C
<b>Storage Humidity</b>	5%~ 90% non-condensing
<b>Regulatory Approvals</b>	
<b>Safety</b>	IEC 60950 (reserved)
<b>EMI</b>	CE/ EN55022 Class A, FCC Class A
<b>EMS</b>	EN61000-4-2 ESD EN61000-4-3 RS EN61000-4-4 EFT EN61000-4-5 Surge EN61000-4-6 CS
<b>Shock</b>	IEC60068-2-27
<b>Vibration</b>	IEC60068-2-6
<b>Free Fall</b>	IEC60068-2-32
<b>Warranty</b>	5 Years

## 5.2 Pin Assignment for RS-232 Console Cable

The total length of the cable is 150cm (58.5”), excluding RJ45 and DB9.

RJ45 Serial Connector	DB-9 serial port to PC
Pin 1	Pin 8
Pin 2	Pin 6
Pin 3 TXD	Pin 2 TXD
Pin 4	Pin 1
Pin 5 GND	Pin 5 GND
Pin 6 RXD	Pin 3 RXD
Pin 7	Pin 4
Pin 8	Pin 7

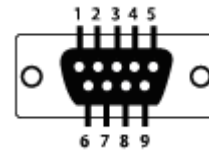

### 5.3 Korenix Private MIB

*Korenix* provides many standard MIBs for users to configure or monitor the switch's configuration through SNMP. But, since some commands can not be found in standard MIB, *Korenix* provides Private MIB to meet the needs. Compile the private MIB file with your SNMP tool. You will then be able to use it. Private MIB can be found in the product CD or downloaded from the *Korenix* Web site ([www.korenix.com](http://www.korenix.com)).

The private MIB tree is the same as the web tree. This is easier to understand and use. If you are not familiar with the standard MIB, directly use the private MIB to manage /monitor the switch, there is no need to learn where the OIDs of the commands are.

The path of *JetNet 4006* is 1.3.6.1.4.1.24062.2.3.1, and the *JetNet 4706f* is 1.3.6.1.4.1.24062.2.3.2. Below is the Private MIB tree for your reference.

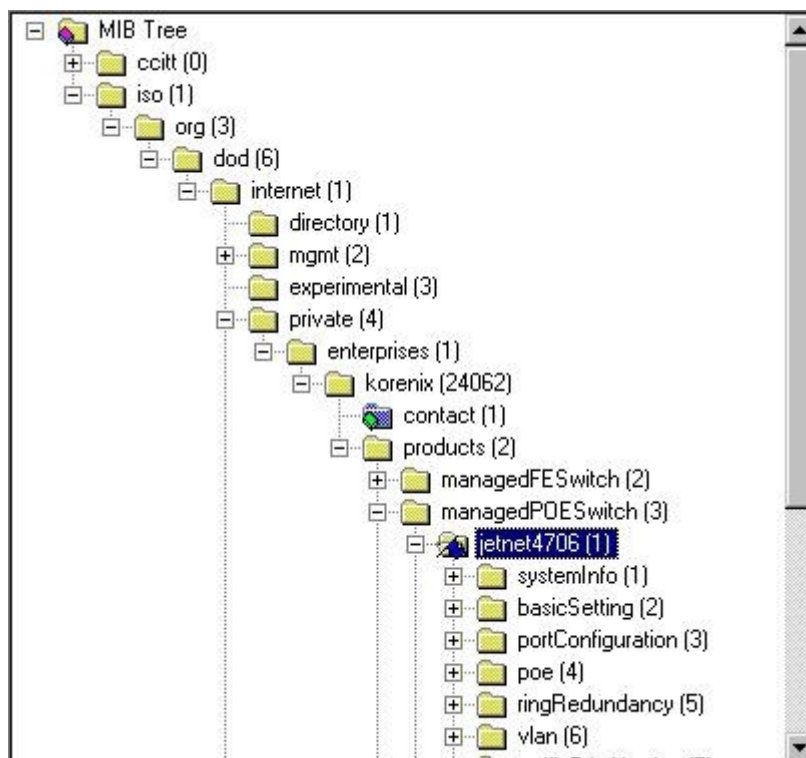

*JetNet 4006/4006f Industrial Managed Switch*



## 5.4 Revision History

Edition	Date	Modifications
V1.0		New edititon.
V1.1	17-DEC,2012	Remove "Port Mirror" words from User Manual



## 5.5 About Korenix

### Save Time and Money On Applications

The *Korenix* business plan is to let you spend less time at work and a smaller budget on your applications. Many people find themselves going through a lot of trouble to end up with low quality products and bad service. This is why *Korenix* is here. *Korenix* offers a complete selection of products that fulfill all your application needs. We provide easier, faster, customized services, and more reliable solutions. At *Korenix*, there is no need to compromise. *Korenix* takes care of everything for you.

### Fusion of Positive Outcomes

You can end your search here. *Korenix* is your one-stop supply center for industrial communications and networking products. *Korenix* was established by a group of professionals with over 10 years of experience in the arenas of industrial control, data communications and industrial networking applications. *Korenix* is geared towards fulfill your demands and expectations by providing a variety of products and services customized to your needs. *Korenix's* industrial-grade products also come with quality services and support. *Korenix* stands by you all the way.

### Core Strength---Competitive Price and Quality

With our work experience and in-depth knowledge of industrial communications and networking, *Korenix* is able to combine Asia's research and development capabilities with competitive production cost and quality support.

### Global Sales Strategy

*Korenix's* global sales strategy focuses on establishing and developing trustworthy relationships with distributors and channel partners, and assisting OEM distributors in the promotion of their own brands. *Korenix* supplies products that exceed local market standards of design, quality, sales, marketing and customer services, allowing *Korenix* and its distributors to design, create and profit together.

### Quality Services

*KoreCARE* is *Korenix's* global service center where our professional staff is ready to solve your problems at any time. All of *Korenix's* products have passed ISO-9000/EMI/CE/FCC/UL certifications. E-mail *KoreCARE* at [koreCARE@korenix.com](mailto:koreCARE@korenix.com)

### 5-Year Warranty

Each of *Korenix's* products are designed, produced, and tested to high industrial standards. *Korenix* warrants that the product(s) shall be free of defects in materials and workmanship for a period of five (5) years from the date of delivery provided that the product was properly installed and used. This warranty is void if defects, malfunctions or failures of the warranted product are caused by damage resulting from forced measures (such as floods, fire, etc.), environmental and atmospheric disturbances, other external forces such as power line disturbances, host computer malfunction, plugging the board in under power, or incorrect cabling; or if the warranted product is misused, abused, or operated, altered and repaired in an unauthorized or improper way.

Korenix Technologies Co., Ltd.

F, No. 100-1, Ming-Chuan Rd., Shing Tien City, Taipei,  
Taiwan Tel: +886-2-8219-3000 Fax: +886-2-8219-3300

**Business service:** [sales@korenix.com](mailto:sales@korenix.com)

**Customer service:** [Korecare@korenix.com](mailto:Korecare@korenix.com)